

CATÁLOGO

Cisamar

Avda. de los Pocillos, 14 - Nave 5
Polígono Industrial La Carrehuela - Ctra. A4 - Km. 29
28343 Valdemoro (Madrid)
Tel.: 91 876 20 76 - Fax: 91 876 20 78
E-mail: cisamar@cisamar.com
www.cisamar.com



Productos Químicos
Automoción e Industria



Anticongelantes, Aceites
y Lubricantes



Portaequipajes



Portaequipajes



Herramientas y
accesorios automóvil



Bocinas y Baterías



Accesorios Automóvil



Accesorios Automóvil



Accesorios Automóvil



Antirrobo



Cables y Cargadores



Deflectores de aire



Lámparas



Lámparas y pilas



Extintores

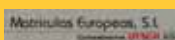

Placas y Matrículas



Filtros Habitáculo



Filtros

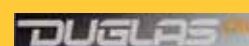

Aceites

Índice

ARTÍCULO	PÁGINA
ACEITE 2T	24
ACEITE HIDRAULICO.....	24
ACEITEMOTOSIERRA.....	24
ACEITES DE MOTOR.....	13-14
ADAPTADOR DE ANTENA.....	57-58
ADHESIVO DE PIEZAS.....	40
AGUADESTILADA.....	12
ALFOMBRAS.....	30-33-81-82-83
ALICATE.....	86
AMBIENTADORES TASSOTI.....	109
ANTENAS.....	37-57-58
ANTICONGELANTE.....	12
ANTIRROBOS.....	26-27-89
APAREJO.....	41
ARMARIO EXTINTORES.....	38
ARRANCADORES.....	4-36-54
ASPIRADOR.....	62
AVISADOR MARCHA ATRÁS.....	11-103
BATERIAS.....	6
BOCINAS.....	28-29
BOLSA MALETERO.....	78
BOMBA INFLAR.....	90



ARTÍCULO

PÁGINA

BOMBA TRASVASE.....	91
BOTIQUINES.....	92
CABLE REMOLQUE.....	35
CABLES ARRANQUE.....	4-36-105
CADENA DE NIEVE.....	7
CALZOS AUTO-CAMIÓN.....	51
CARGADORES BATERÍA.....	4
CEPILLOS Y BARRAS.....	33-61
CHALECO.....	52
CINCHAS.....	60
CINTA DECORATIVA.....	53
CINTA DOBLE CARA.....	55
CINTURONES.....	51-78
COLA ESCAPE.....	93-94
COMPRESOR AIRE.....	54
CORTINILLAS.....	31-81
CUBETA ACEITE.....	92
EMBUDOS.....	91
ENCHUFE MECHEREO.....	97-105-106
ENCHUFES REMOLQUE.....	108
ENCHUFE ANTENA.....	57
ENGANCHE - BARRA ACC. CARAVANA.....	52
ESCOBILLAS.....	42
ESPÁTULA.....	62
ESPEJOS.....	31-80-94-95

ARTÍCULO	PÁGINA
ESTRELLASMERCEDES.....	53
EXTINTORES.....	38
EXTRACTOR ACEITE.....	90
FALDILLAS.....	96
FILTROS.....	5-53-85
FLÉXOMETRO.....	55
FUNDA PALANCA CAMBIO.....	79
FUNDAS ASIENTO.....	30-33
FUNDAS DE TELA NIEVE.....	7
FUNDAS VOLANTE.....	30-31-33-84
FUSIBLES Y PORTAFUSIBLES.....	34-97-102
GAMUZAS.....	32-61
GATOS.....	54-88
GRASA LITIO.....	25
GUANTES.....	32
INDICADOR LED.....	101
INTERRUPTOR PRESIÓN.....	101-105
INTERRUPTOR BATERÍA.....	97
INTERRUPTORES.....	101
LAMINA SOLAR.....	31
LÁMPARA FLEXO.....	103
LÁMPARAS.....	10-11-63 AL 74
LAVAPARABRISAS.....	12
LINTERNAS.....	56
LÍQUIDO DE DIRECCIÓN.....	15-16



ARTÍCULO

PÁGINA

LÍQUIDO DE FRENOS.....	16-25
LÍQUIDO SERVO DIRECCIÓN.....	25
LLAVES FILTRO.....	85
LLAVES CARTER-FUERZA Y VARIAS.....	85-86
LLAVES RUEDA.....	55
LUZ ILUMINACIÓN TRASERA.....	107
MANGOS CEPILLOS.....	33-61
MEDIDOR PRESIÓN.....	87-88
MULTIDOSIS.....	39
NAVAJA.....	86
PAPEL.....	32
PARASOL.....	31-80-81
PASTA LAVAMANOS.....	32-33
PEGAMENTO LUNA.....	41
PINZAS BATERÍA.....	34-103
PLACAS MATRÍCULAS ALUMINIO Y ACRILICAS.....	43-44-45
PLACAS SEÑALES.....	46-47-48-49
PLUMEROS.....	61
POMO VOLANTE.....	79
PORTA MONEDAS.....	52
PORTAEQUIPAJES.....	3
PORTAFUSIBLES.....	97
PORTÁTIL.....	56
PROLONGADOR ANTENA.....	57
PROTECTOR PARAGOLPES.....	53-93-95



ARTÍCULO

PÁGINA

PROTECTOR ASIENTO.....	78
PROTECTOR GARAJE.....	53
PROTECTOR PUERTA.....	93
PULPOS.....	53-60
QUITA RAYAS.....	40
REDES.....	78
REFLECTANTE.....	107
RELES.....	100-101
REPARADOR PLÁSTICOS BICOMPONENTE.....	40
REPARAPINCHAZOS.....	54-88-89
REPELENTE DE LLUVÍA.....	40
RESPALDOS.....	30-75-76
RESTAURADOS FAROS.....	40-41
ROTATIVOS.....	50
ROTULADOR RUEDA.....	59
SEPARACARGAS.....	51-77
SEPARAPERROS.....	51-77
SEPIOLITA.....	33
TAPACUBOS.....	8-9
TAPÓN ANTENA.....	58
TAPÓN EMERGENCIA.....	89
TAPONES ACEITE.....	52
TAPONES VÁLVULA.....	59
TERMINALES BATERÍA.....	35-101-102
TERMINALES FLAXTON.....	97 AL 100



ARTÍCULO	PÁGINA
TESTER.....	87
TIRA ANTIESTÁSICA.....	96
TOMA CORRIENTE.....	35
TOMA USB.....	105-106
TORNILLOS ANTORROBO.....	51
TRANSFORMADORES.....	104-105
TRIANGULOS AVERÍA.....	52
VALVULINA.....	15-24
VENTILADOR.....	36-105



MIL Y UNA SOLUCIONES



AUTOMOTIVE & INDUSTRY



Lider en productos de calidad
50 años de experiencia
Productos que respetan el medio ambiente
Continúa innovación
Delegación centro.
Consultar catálogo general





FERVE
THE BATTERY LIFE



**CONSULTAR
TARIFA Y
CATÁLOGO**



FILTROS MILLARD



FLITROS ZAPOS



FILTROS HABITACULO
MARCA SIARIA.
VER CATALOGO GENERAL

FIAMM



BATERIAS FIAMM TURISMO



BATERIAS MOTO



BATERIAS FIAMM 4X4 Y CAMION

MOD. 30 REF. 69150030	MOD. 70 REF. 69150070	MOD. 100 REF. 69150100
MOD. 40 REF. 69150040	MOD. 80 REF. 69150080	MOD. 110 REF. 69150110
MOD. 50 REF. 69150050	MOD. 90 REF. 69150090	MOD. 120 REF. 69150120
MOD. 60 REF. 69150060	MOD. 95 REF. 69150095	MOD. 130 REF. 69150130

MOD. 360 REF. 69200360	MOD. 400 REF. 69200400	MOD. 470 REF. 69200470
MOD. 370 REF. 69200370	MOD. 410 REF. 69200410	MOD. 480 REF. 69200480
MOD. 380 REF. 69200380	MOD. 450 REF. 69200450	MOD. 490 REF. 69200490
MOD. 390 REF. 69200390	MOD. 460 REF. 69200460	



MOD 70	MOD 76
REF. 69250070	REF. 69250076
MOD 71	MOD 77
REF. 69250071	REF. 69250077
MOD 72	MOD 78
REF. 69250072	REF. 69250078
MOD 73	MOD 79
REF. 69250073	REF. 69250079
MOD 74	MOD 80
REF. 69250074	REF. 69250080
MOD 75	MOD 81
REF. 69250075	REF. 69250081



JGO TAPACUBOS



JGO TAPACUBOS 417 - 15



JGO TAPACUBOS 437-15



JGO TAPACUBOS 923-14



- 16476 JGO 4 TAPACUBOS COSMOS BLANCO 13
- 16477 JGO 4 TAPACUBOS COSMOS BLANCO 14
- 16478 JGO 4 TAPACUBOS COSMOS BLANCO 15
- 16479 JGO 4 TAPACUBOS COSMOS BLANCO 16



16459 JGO 4 TAPACUB. AURA NEGRO 15
 16463 JGO 4 TAPACUB. COSMOS NG 13
 16470 JGO 4 TAPACUB. COSMOS NG 15



JGO TAPACUBOS
 025050071 13"
 025060071 14"
 025070071 15"
 025080071 16"



JGO 4 TAPACUBOS
 1450601004 SEGOVIA 13
 1450601005 SEGOVIA 14
 1450601006 SEGOVIA 15



JGO 4 TAPACUBOS
 1450601007 TOLEDO 14
 1450601008 TOLEDO 15



JGO 4 TAPACUBOS
 1450601001 MADRID 14
 1450601002 MADRID 15
 1450601003 MADRID 16



161144 ESTUCHE 2 LAMPARAS PLASMA WHITE H4 12V
 161154 ESTUCHE 2 LAMPARAS PLASMA WHITE H1 12V
 161164 ESTUCHE 2 LAMPARAS PLASMA WHITE H7 12V



161344 ESTUCHE 2 LAMPARAS AZUL H4 12 V 60% +LUZ
 161354 ESTUCHE 2 LAMPARAS AZUL H1 12V 60%+LUZ
 161364 ESTUCHE 2 LAMPARAS AZUL H7 12 V 60% +LUZ
 161374 ESTUCHE 2 LAMPARAS AZUL H3 12 V 60% +LUZ



44SETH4XV SET H4 12V EXTREME VISION
 44SETH7XV SET H7 12V EXTREME VISION
 44SETH1XV SET H1 12V EXTREME VISION



44SETH1BV SET H1 12V BLUE VISION
 44SETH4BV SET H4 12V BLUE VISION
 44SETH7BV SET H7 12V BLUE VISION



LAMPARAS JHANN
 VER CATALOGO GENERAL



LAMPARAS PHILIPS
 H1, H3, H4, H7, 1P, 2P, S/ CASQ, PLAFON, MATRICULA.



022810367
AVISADOR MARCHA ATRAS 12V 21W



1450605002
LAMPARA H1 12V 55W BL 1U
450605004
LAMPARA H4 12V 60-55 W BL1U 1
450605006
LAMPARA H7 12V 55 W BL1U
1450605001
LAMPARAS LED BLANCA SALP
POSICION POSC BL2U
1450605008
LAMPARA 1POLO 12V 21W BL2U
1450605011
LAMPARA 2 POLOS 12V 21-5W BL 2U
1450605013
LAMPARA MATRICULA 12V 5W BL 2U
1450605015
LAMPARA 12V 5W SIN CASQUILL. BL 2 U



1450605009
LAMPARA 1 POLO 12V 21W EN CAJA
1450605010
LAMPARA 1 POLO AMBAR 12-21V BAU 15S
1450605012
LAMPARA 2 POLOS 12 V 21-5 W EN CAJA



1450605014
LAMPARA MATRICULA 12V 5W EN CAJA
1450605016
LAMPARA 12V 5W SIN CASQ. EN CAJA
1450605017
LAMPARA PLAFONIER 12V 5W EN CAJA



1450605003
LAMPARA H1 12V 55W EN CAJA
1450605005
LAMPARA H4 12V 60-55W EN CAJA
1450605007
LAMPARA H7 12V 55W EN CAJA



ANTICONGELANTE PURO
1L- 5L - 25L - 200L



ANTICONGELANTE ORGANICO
VERDE - ROSA 30%
1L- 5L - 25L - 50L - 200L



ANTICONGELANTE ORGANICO
ROSA 50% G12 Y VERDE 50%
5L - 25L - 50L - 200L



LAVAPARABRISAS GARRAFA
1L - 5L - 20L



AGUA DESTILADA
1L - 5L - 25L



59A1.1 ACEITE GTX ECO C4 5W30 1L
59A1.2 ACEITE GTX ECO C4 5W30 5L



59A2.1 ACEITE GtX ULTRA C3 LL 1L
59A2.2 ACEITE GtX ULTRA C3 LL 5L



59A5.1 ACEITE GTX CLEAN C3 5W40 1L
59A5.2 ACEITE GTX CLEAN C3 5W40 5L



59B3.1 ACEITE GYS Ultra SYNT 5W30 1L
59B3.2 ACEITE GYS Ultra SYNT 5W30 5L



59A6.1 ACEITE GTX MAX C3 5W30 1L
59A6.2 ACEITE GTX MAX C3 5W30 5L



59B1.1 ACEITE GTS EVO SYNT 5W40 1L
59B1.2 ACEITE GTS EVO SYNT 5W40 5L



59B4.1 ACEITE GTS MAX 10W40 1L
59B4.2 ACEITE GTS MAX 10W40 5L



59C1.1 ACEITE GT PLUS 15W40 1L
59C1.2 ACEITE GT PLUS 15W40 5L



59C3.1 ACEITE GT SUPREME 15W40 1L
59C3.2 ACEITE GT SUPREME 15W40 5L



59C4.1 ACEITE GT PLUS 20W50 1L
59C4.2 ACEITE GT PLUS 20W50 5L



59F3.2 LUBRICANTE HIDRAUL.UTTO
80 10W30 5L





59G1.1 DEXRON VI 1L
59G1.2 DEXRON VI 5L



59G3.1 DEXRON III 1L
59G3.2. DEXRON III 5L



59G4.1 DEXRON II 1L
59G4.2 DEXRON II 5L



59H2.1 VALVULINA SUERGEAR 75W80 1L
59H2.2 VALVULINA SUERGEAR 75W80 5L



59H3.1 VALVULINA SUPERGEAR 75W90 1L
59H3.2 VALVULINA SUPERGEAR 75W90 5L



59H5.1 VALVULINA SUPERGEAR 80W90 1L
59H5.2 VALVULINA SUPERGEAR 80W90 5L





59M2.1 LÍQUIDO DE FRENOS DOT4 1L



59M3.1 LÍQUIDO DIRECCIÓN LHM 1L



GTx LINE
 INNOVATIVE LOW SAPS TECHNOLOGY
 100% SYNTHETIC FORMULATION

GTx ECO C4 5W-30
 API SN/CF · ACEA C4-12 · MB229.51 · RN 0720

GTx ULTRA 5W-30 C3 LL IV
 API SN SM/CF · ACEA C3-12 A3/B4-12 · MB229.51-229.31 · BMW LL-04 · VW504.00/507.00 505.01/506.01 · PORSCHE C30

GTx ENERGY FE C1 5W-30
 API SN/CF · ACEA C1-12 · FORD/JAGUAR WSS M2C-934-B · JASO DL-1 · MAZDA · NISSAN · SUBARU



GTx LIGHT FE C2 5W-30
 API SN SM/CF · ACEA C2-12 · FORD WSS M2C-913-D-C-B-A · PSA B712290 · FIAT 9.55535.S1 · TOYOTA · LEXUS · NISSAN · SUBARU · HONDA

GTx CLEAN C3 5W-40
 API SN SM/CF · ACEA C3-12 · MB229.51-229.31 · BMW LL-04 · VW502.00/505.00/505.01 · FIAT 9.55535-S2 · FORD WSS-M2C917A · GM DEXOS 02 · RENAULT RND700 RND710 · PORSCHE A40

GTx MAX C3 5W-30
 API SN SM/CF · ACEA C3-12 · MB229.51-229.31 · BMW LL-04 · VW502.00/505.00/505.01 · FIAT 9.55535.S2 · GM DEXOS 02 · PORSCHE A40



GTs LINE
 SYNTHETIC TECHNOLOGY
 SYNTHETIC FORMULATION

GTs EVO-SYNT 5W-40
 API SN/CF · ACEA A3/B4 · VW501.01-502.00-505.00-505.01 · MB229.3-229.5 · BMW LL04 · GM-LL-B-025 · RENAULT RND700 RND710 · PORSCHE A40

GTs ULTRA-SYNT 5W-40
 API SL SJ/CF · ACEA A3/B3 · MB 229.1 · VW502.00-505.00

GTs ULTRA-SYNT 5W-30
 API SL/CF · ACEA A5/B5 A1/B1 · FORD WSS M2C-913C

GTs MAX 10W-40
 API SN SM/CF · ACEA A3/B4 MB229.1 · VW 501.01-502.00-505.00 · BMW LL-01 · PORSCHE

GTs ECO Gas 10W-40
 API SL/CF · ACEA A3/B3 · MB229.1 · VW 502.00-505.00

GTs 10W-40
 API SJ/CF · ACEA A3/B3 · MB229.1 · VW 500.00-501.01-505.00



GT LINE

ADVANCED TECHNOLOGY

MINERAL FORMULATION



GT PLUS 15W-40

API SL/CF · ACEA A3/B4 · MB229.1 · VW 501.01-505.00

GT MAX 15W-40

API SJ/CF/CF-4 · ACEA A3/B3 · MB228.1 · VW 500.00-505.00

GT SUPREME 15W-40

API SG SF/CD

GT PLUS 20W-50

API SG SF/CD

GT MONOGRADE 30-40-50

API SF/CD



1L

4L

5L

20L

200L

IBC 1000L

HEAVY DUTY

Lubrificanti per la trazione Diesel Pesante / Heavy Duty Diesel Oil



ULTRA HC FE 5W-30 UHPDO / 100% SYNTHETIC - EURO V-IV e DPF

ACEA E6-E9 E4-E7 · API CJ-4/CI-4/CH-4 · MB228.51-228.5-228.31 · VOLVO VDS-3 · SCANIA LDF · RENAULT RVI RXD · MAN M3477-3277 · MTU TYPE3 · CUMMINS CES 20077/20076/20072/20071 MACK EO-M PLUS

ULTRA HC LS 10W-40 UHPDO / SYNTHETIC TECHNOLOGY - EURO V-IV e SCR

ACEA E6-E9 E7 · API CJ-4 · MB228.51-228.31 · DAF HP-2 · VOLVO VDS-3 · RENAULT RVI RXD/RLD-2 · MAN M3477/3277CRT · DAF HP-2 · SCANIA LA · MTU TYPE 3.1

ULTRA HC 10W-40 UHPDO / SYNTHETIC TECHNOLOGY - EURO V-IV-III

ACEA E4-E7 · API CI-4 PLUS · MB228.5-228.3 · MAN M3277 · VOLVO VDS3 · SCANIA LDF-2/3 · MTU TYPE3 · CUMMINS CES 20072 · RENAULT RVI RXD/RLD-2 · DAF · MACK EO-M/EO-M PLUS · DEUTZ DQC IV-10

SUPER LIFE LS 15W-40 SHPDO / NEW TECHNOLOGY BASED

ACEA E9-E7 · API CJ-4/SL · MB228.31 · MAN 3575 · VOLVO VDS-4 · RENAULT RVI RLD-3 · MTU TYPE 2.1 · DEITZ DDC 93K218 · CAT ECF 1-A/2/3 · CUMMINS CES 20081 · MACK EO-D PREMIUM PLUS

SUPER LIFE 10W-40 SHPDO / SYNTHETIC TECHNOLOGY

ACEA E3/E5/E7 A3/B4 · API CI-4/SL · MB228.3/229.1 · MAN M3277 · VOLVO VDS3 · MTU TYPE2 · CAT ECF-2 · MACK EO-M PLUS · RENAULT RVI RLD-2 · CUMMINS CES 20077

SUPER LIFE 15W-40 SHPDO / NEW TECHNOLOGY BASED

ACEA E7 · MB228.3 · API CI-4/CH-4 · MAN M3275 · VOLVO VDS-2/3 · RENAULT RVI RLD-2 · MTU TYPE3 · CAT ECF-2 · MACK EO-M PLUS · CUMMINS CES 20078/20077/20076/20072/20071

SUPER LIFE 20W-50 SHPDO / NEW TECHNOLOGY BASED

ACEA E7 · MB228.3 · API CI-4/CH-4 · MAN M3275 · VOLVO VDS2/3 · RENAULT RVI RD-2 · MTU TYPE2 · CUMMINS CES 20076 · MACK EO-M PLUS

SUPER DT 15W-40 HPDO / MINERAL BASED

API CG-4/CF-4/SJ · ACEA E2 · MB228.1 · MAN M271 · VOLVO VDS · CAT ECF-1-A · CUMMINS CES 20076/20071 · MACK EO-M

HD S3 SAE 30/40/50 / MINERAL BASED

ACEA E2 · API CF-4/CF



5 L

20 L

200 L

IBC 1000L

GREEN LINE

Lubrificanti per agricoltura e movimento terra / Farm Tractor and OFF-Highway Oil



PREMIUM 15W-40 S.T.O.U. / ADVANCE TECHNOLOGY

API CG-4/SF · ACEA E3 · API GL-4 · MB 228.1 · JD J27-J20C/D · FORD M2C 159B/C-134D
NH 82009201/2/3 CNH MAT 3525-3526 · ZF TE-ML 06A/B, 07B · MF CMD M1145-M1144-1139-1143-1135

PREMIUM 10W-30 S.T.O.U. / ADVANCE TECHNOLOGY

API CG-4/SF · ACEA E3 API GL-4 · MB 228.1 · JD J27-J20C/D · FORD M2C 159B/C-134D NH 82009201/2/3 ·
CNH MAT 3525-3526 ZF TE-ML 06A/B, 07B · MF CMD M1145-M1144-1139-1143-1135

U.T.T.O. 80W / 10W-30 / ADVANCE TECHNOLOGY

API GL-4 · ALLISON C4 · CAT TO-2 · FORD M2C 134D · JD J20C · CNH MAT 3525- 3526 · KUBOTA UDT · MF CMS M1143-M1135-M1145 ·
ZF TE-ML 03E, 05E · VOLVO WB101

HD 30/50 TO-4 / ADVANCE TECHNOLOGY

CAT TO-4 · ALLISON C4 · KOMATSU MICRO CLUTCH

HD 10W TO-4 / ADVANCE TECHNOLOGY

CAT TO-4 · ALLISON C4 · KOMATSU MICRO CLUTCH

GREEN 15W-40 S.T.O.U. / ADVANCE TECHNOLOGY

API GL-4/CF-4 · CAT TO-2 · ALLISON C4 · JD J27 · MF M1139

GREEN 80W/20W-30 U.T.T.O. / ADVANCE TECHNOLOGY

API GL-4 · CAT TO-2 · ALLISON C4 · JD J20C · MF M1135

GREEN 10W / ADVANCE TECHNOLOGY

CAT TO-2 · ALLISON C3

GREEN 4T 15W-30 / ADVANCE TECHNOLOGY

API SG/CD · ACEA A2



5 L

20 L

200 L

IBC 1000L

MOTORCYCLES LINE

Lubrificanti per Moto / Motorcycles Lubricants



SUPER TTS SYNT / 100% SYNTHETIC

API TC PLUS · JASO FD · ISO-L-EGD

STS PLUS MIX 2T

API TC · JASO FC

SUPER 4T 10W-40 / SYNTHETIC TECHNOLOGY

API SM · JASO MA2



1 L

5 L

20 L

200 L

IBC 1000L

AUTOMATIC LINE

Lubrificanti per trasmissioni automatiche / Automatic Transmission Lubricants



ULTRA ATF VI / 100% SYNTHETIC

GM DEXRON VI · ZF TE-ML 09 · VOITH 55.6335 · ALLISON C4 · CAT TO-2 · VOLVO 97340 · MB 236.5

SUPER ATF DEXRON III SYNT / 100% SYNTHETIC

GM DEXRON III-IIIH-III E · MB 236.5-236.9-236.10-236.11-236.12 · VOITH G607 · ALLISON C-4 · CAT TO-2 · ZF TE-ML 02F, 03D, 04D, 14B, 16L, 17C · MAN 339 V2/Z2 · VOLVO 97341 · FORD MERCON V

ATF DEXRON III / SYNTHETIC TECHNOLOGY

GM DEXRON III - III G · MB 236.5-236.9 · ZF TE-ML 02F, 03D, 04D, 09B, 11B, 14A, 17C · VOITH G607 · FORD MERCON V · ALLISON C-4 · CAT TO-2

ATF DEXRON IID / ADVANCE TECHNOLOGY

GM DEXRON IID · ZF TE-ML 02F, 03D, 04D, 09A, 11A-B, 14A, 17C · VOITH 55.6335.32 (G607) · MAN 339D · ALLISON C4 · CAT TO-2 · MB 236.1-236.7 · FORD MERCON M2C 138CJ

TRANSMISSION LINE



Lubrificanti per trasmissioni meccaniche / Mechanical Transmission Lubricants

SUPERGEAR 75W-140 / SYNTHETIC TECHNOLOGY

API MT-1/GL-4+ · ZF TE-ML 02D · MAN 341 Z3/E3/TL · MB 235.4 · SCANIA STO 1.0

SUPERGEAR 75W-80 / SYNTHETIC TECHNOLOGY

API MT-1/GL-4+ · ZF TE-ML 02D · MAN 341 Z3/E3/TL · MB 235.4 · SCANIA STO 1.0

SUPERGEAR 75W-90 / SYNTHETIC TECHNOLOGY

API MT-1/GL-4/GL-5 · MAN 341 E3/3343 S · MB 235.8/235.11 · ZF TE-ML 02B, 05B, 07A, 12B, 16F, 17B, 19C, 21B

SUPERGEAR 85W-140 / ADVANCE TECHNOLOGY

API GL-5 · MIL-L-2105D · MB 235.1 · VOLVO 97319 · SCANIA STO 1.0 · ZF TE-ML 05A, 12E, 16D, 17B, 19B, 21A

SUPERGEAR 80W-90 / ADVANCE TECHNOLOGY

API GL-4/GL-5 · MIL-L-2105D · MAN 341 Z1/E1, 342 M1/M2 · VOLVO 97310 · ZF TE-ML02B, 05A, 07A, 12E, 16A, 16B-D, 17A, 17B, 19A, 19B, 21A · SCANIA STO 1.0

GEAR ZC 140 / NEW TECHNOLOGY

API GL-4 · MAN 342M1 · MB 235.0 · VOLVO 97310 · ZF TE-ML 07A, 16A, 17A, 19A, 21A

GEAR ZC 90 / NEW TECHNOLOGY

API GL-4 · MAN 342M1 · MB 235.0 · VOLVO 97310 · ZF TE-ML 07A, 16A, 17A, 19A, 21A

GEAR 250

API GL-4 · MIL-L-2105C



MARINE LINE

Lubrificanti per nautica Outboard / Nautical Outboard Lubricants



OUTBOARD 2T

NMMA TCW-III

OUTBOARD 4T 15W-40

API SM JASO MA2



GREASE LINE

GRASSI LUBRIFICANTI/GREASES



GREASE MOLY

N.L.G.I. 2 · ISO-L-X-BCHB

GREASE L2

N.L.G.I. 2 · ISO-L-X-BCHA

GREASE L2 EP

N.L.G.I. 2 · ISO-L-X-BCHA EP

GREASE UNIVERSAL GREEN

N.L.G.I. 2 · ISO-L-X-BAGA



 **FUNCTIONAL LINE
ANTIFREEZE LINE**

**FLUIDI FUNZIONALI /
FUNCTIONALS FLUID**



SUPER BRAKE FLUID DOT5.1
SAE J 1703 · FMVSS 116 DOT4-DOT5.1 · ISO 4925 · VW/AUDI ·
FERRARI AUTO · MASERATI

SUPER BRAKE FLUID DOT4
SAE J 1703 · FMVSS 116 DOT3-DOT4 · ISO 4925 ·
CUNA NC 956 DOT4 · IVECO 18-1820

SUPER LHM
CITROEN PSA B-712710 · FIAT LHM

ANTIGELO / ANTIFREEZE

SUPER ANTIFREEZE / LONG LIFE TECHNOLOGY
RED COLOR · ASTM D 3306 TYPE3 · CUNA NC 956-16 ·
VW TL 774 D/F (G12/G12+) · MB 325.3 · MAN 324 SNF · GM 6277MI

POLAR ANTIFREEZE
CUNA NC 956-16 · ASTM D 3306 TYPE1 ·
ASTM D 6210 TYPE 1-FF · VW TL 744C (G11)

POLAR -40
ASTM D 3306 TYPE3 · CUNA NC 956-16

1 L 5 L 20 L 200 L IBC 1.000L



DUGLAS OIL



6010206 VALVULINA SAE 140 5L



6000304 ACEITE MEZCLA 2T SINT 5L
6010301 ACEITE MEZCLA 2T SINT 1L



6000405 ACEITE SUPER SERIE III SAE 40 5L
6001030 ACEITE HIDRAULICO 10W30 5L
6010604 ACEITE HIDRAULIC. 46 EP-HM 5L



60LHM5 LÍQUIDO DIRECCIÓN LHM 5L



600600 D ACEITE PARA GUIAS SAE 30 5L
6010304 ACEITE CADENA MOTOSIERR. 5L



6000804 GRASA CALCIC. ANHIDRA 407 5KG
6000904 GRASA LITICA 450EP 5KG



6000604 GRASA LITIO CON BISULF. 441 5KG
6004405 GRASA LITIO SILVERGRAS 440 5L
6004423 GRASA LITIO SILVERGRAS 440 23 KG
6004450 GRASA LITIO SILVERGRAS 440 45KG



60DOT3 LIQ. DE FRENOS DOT3 500CC
60SWG500 LIQ SERVO-DIREC AUDI-VW
500 cc

TOP
VENTAS



1450604002
ANTIROBO VOLANTE SALPICADERO
LLAVE PLANA

TOP
VENTAS



27009008
ANTIROBO VOL-SALP MAXTON 955B



2700701 AMARILLO
2700700 BLANCO
ANTIROBO. SPORT CLUBFIJACION
VOLANTE.



2700 9003
ANTIROBO SALPICD. BLOCKAUTO 954
27009009
ANTIROB. SALPIC. BLOCKAUTO 9595



27009005
ANTIROBO ROJO PEDAL-VOL 571 R
27009007
ANTIROBO SALPIC. REFORZADO 869



27009018
ANTIROBO PEDAL-VOL 580 A
27010008
ANTIROBO MOTO 1002 CM 523PB



27009019 ANTIROBO VOL-PEDAL 905
 27009035 ANTIROBO ASIENTO - VOL 585B
 27009036 ANTIR. ASIENTO VOL 80CM 582B



27009040
 ANTIROB. BUNKER ASIENTO- VOL BA50N
 27009041
 ANTIROB. BUNKER ASIENTO- VOL BA80N
 27009042
 ANTIROB. BUNKER PEDAL - VOL BP80B



27009043
 ANTIROBO BUNKER PEDAL-VOL BT 29B
 27009044
 ANTIROBO BUNKER PEDAL-VOL BB83B



39R100
JGO BOCINA REKORD 1P 12V
39R200
JGO BOCINA REKORD 2P 12V



39R09512V
CLAXON REKORD 2T 12V
39R09524V
CLAXON REKORD 2T 24V



39TEMGAS-I
BOCINA GAS COMPLETA
39CARGATEM-I
CARGA BOCINA GAS



39R105 12V BOCINA PLASTICO
39R107 12V BOCINA METAL



39161016
JGO BOCINAS FIAMM 2P 12V AM80 S1
39161017
JGO BOCINAS 1P 12V AM80 S
39MC2FD24
COMPRESOR POLICIA-AMBULANCIA 24V
39TR9912V
JGO BOCINA CAMION ELECT 2P 12V
39 TR9924V
JGO BOCINA CAMION ELECT 2P 24V



39920995
CLAXON 12V 2 POLOS FIAMM MK-9H



26060005
JGO ALF MOQUETA UNIVERSAL NEGRA
26060007
JGO ALF MOQUETA UNIVERSAL GRIS
-
JGO ALF UNIV MOQ BORDADO POR MARCA
-
JGO ALF MOQ A MEDIDA POR COCHE.



26003006
RESPALDO DON FRESCO MODELO SILVER



23040344
FUNDA ASIENTO MATRIX AZUL 1U
23040345
FUNDA ASIENTO MATRIX GRIS 1U



REF 26003537
FUNDA VOLANTE PIEL 35-37
REF 26003739
FUNDA VOLANTE PIEL 37-39



1450602001
JGO ALFOMBRAS GOMA UNIVERS REVERSIBLES

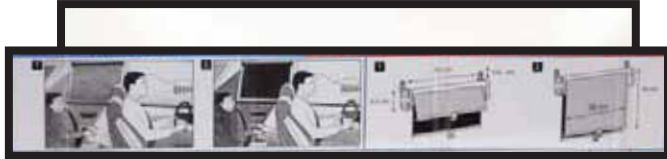

02CLD4350
CORTINILLA LATERAL DOBLE 43X50



LAMINA SOLAR HOMOLOGADA
024004020 NEGRA 76X300
024004050 100%NEGRA 76X300



PARASOL DELANTERO
02LASER10 TALLA M 143X60
02LASER20 TALLA L 145X70
02LASER30 TALLA XL 145X80



1640743NG
CUBREVOLANTE NEGRO 42-45
45000823
PARASOL CUBRE VOLANTE



022808460
ESPEJO SUPERPANORAMICO XL 43CM



52000004
PASTA LAVAMANOS CSM 25Kg
52000005
PASTA LAVAMANOS CSM 5Kg



52222010
GAMUZA KANEBO GRANDE



52222016
BOBINA INDUSTRIAL COLHOGAR
2C 450m



52222017
BOBINA INDUSTRIAL 2C LISA



52300420
SOPORTE PARA BOBINA PIE INOX.



52NITRILOM
CAJA GUANTE NITRILO T-7 - 8



52221238
 CEPILLO LAVACoch. ESPECIAL (REF 404)
 52222045
 CEPILLO LAVACochES 404 PVC NG
 52222046
 CEPILLO LAVACochES 606 PVC NG
 52222047
 CEPILLO AUTOBUS 707 PVC NG



52222028
 BARRA METÁLICA 1 metro
 52222029
 BARRA METÁLICA 1,80 metros ,
 52222031
 BARRA ALUMINIO 1 m.



52990450
 CUBRE VOLANTE ELASTICO (CAJA 250 U)
 52990462
 BOBINA FILM VOL(CAJ.10U + 1 EMPUÑD)



52990241
 BOBINA FUNDA ASIENTO 250 U
 52990242
 BOBINA 500 ALFOMBRILLAS SUELO



52222014
 SACO SEPIOLITA 20 KG



06015045
 JABON DE MANOS ECOLOGICO 10L

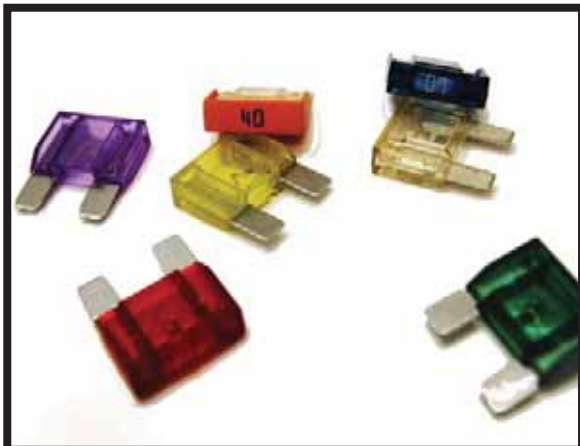

FUSIBLE MAXI
20-30-40-50-60-70-80 Y 100 AMP



47134200
CAJA FUSIBLES PLANOS
100U SP 020200K

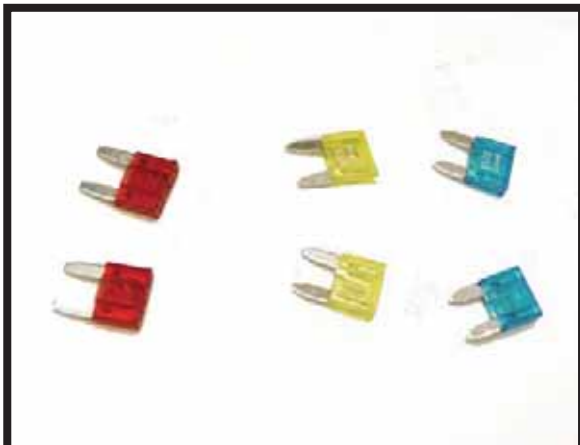

FUSIBLE MINI
3-4-5-7,5-10-15-20-25-30 AMP

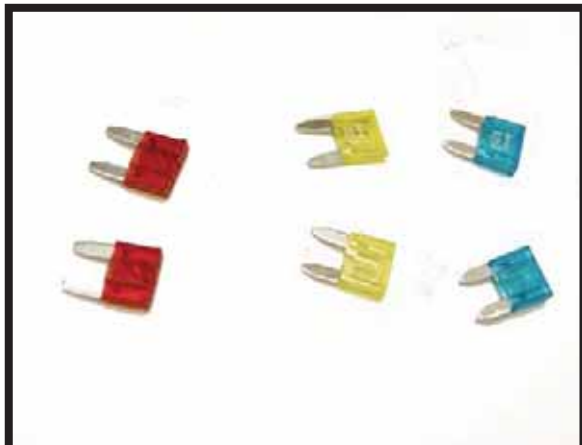

FUSIBLE PLANO
3-4-5-7,5-10-15-20-25-30 Y 40 AMP



47167025
PINZA BATERIA LATON 350 AMP NEGRA
47167026
PINZA BAT. LATON AMP 350 AMP ROJA
47907259
PINTA BATERIA LATON 250 AMP ROJA
47907260
PINTA BATERIA LATON 250 AMP NEGRA



47135102
 TERMINAL BAT. REFORZADO + (TB102)
 47135103
 TERMINAL BAT. REFORZADO - (TB103)



47135098
 TERMINAL BATERIA + (TB100-TB14)
 47135099
 TERMINAL BATERIA - (TB101 - TB17)



47DB1001
 DESCONECTADOR BATERIA TURISMO
 47DB1002
 DESCONECTADOR BATERIA CAMION



47135097
 TERMINALES BATERIA VARIOS
 TIPOS KIT 2 TERMINALES +/-



3570880
 BASE TOMA CORRIENTE UNIVERSAL
 CON TAPA



48CR1001
 CABLE REMOLQ. CORTO 6 CONEXIONES
 48CR1004
 CABLE REMOLQ. LARGO 6 CONEXIONES



47100000
MINI ARRANCADOR PORTATIL
LAUNCH



022404015
VENTILADOR 12V



1450604001
JGO CABLE ARRANQUE 400 AMP 3.5M



Ref	Descripción	Medida	C. Barras	Und/ Caja
NOVEDADES				
10001	Repuesto Varilla Antena negra (3 adaptadores)	36 cm	8414110100017	6
10030	Repuesto Varilla Antena Tipo "GOLF" (2 adaptadores)	42 cm	8414110100307	6
09999	Repuesto Varilla Antena Tipo "MINI-GOLF" (2 adaptadores)	24 cm	8414110099991	6
09998	Repuesto Varilla Antena Goma "FLEXIBLE" (2 adaptadores)	18 cm	8414110099984	6
09997	Repuesto Varilla Antena Tipo "MINI" (2 adaptadores)	17 cm	8414110099977	6



EXTINTOR DE POLVO
 49209001 1 KG
 49209002 2 KG 13A 89B-C
 49A00500 3KG



EXTINTOR DE POLVO
 49209016 6 KG 34A 183B
 49209006 6KG 27A 183B



EXTINTOR DE POLVO
 49209009 9 KG 43A 233B
 49209010 12KG 55A 233B



EXTINTOR CO2
 49209018 HIERRO. 5KG K5 5ST



ARMARIO EXTINTOR CON CRISTAL
 6-9-12KG



53G5CRISTALES
 LIMPIACRISTALES 5L
 53MDA 15001
 LIMPIACRISTALES 150 ml



53G5LLANTASSF
 LIMPIALLANTAS SIN FROTAR 5L
 53MDA15005
 LIMPIALLANTAS SIN FROTAR 150 ml



53G5MULTIUSOS
 LIMPIADOR MULTIUSOS 5L
 53MDA15003
 LIMPIADOR MULTIUSOS 150 ml



53G5SALPI
 LIMPIASALPICADEROS 5L
 53MDA 15004
 LIMPIASALPICADEROS 150 ml



AMBIENTADORES 5L
 LIMON, PINO, FRESA, COCO, MANZANA,
 MENTA, FRAMBUESA, VAINILLA



53MOTMD20CAS LIMPIA CASC. MOTO 20ml
 53MOTMD20PAN LIMPIAPANTALL.MOTO 20ml
 53 MOTMD20PLAS LIMPIA PLASTIC. MOTO 20ml
 53NANO20 REPELENTE DE LLUVIA 20ml
 53ADID01 ADITIVO DIESEL CSM
 53ADIG01 ADITIVO GASOLINA CSM
 53ADIL01 LAVAPARABRISAS CONCENTRADO CSM
 53MDI2001 LIMPIAPANTALLAS CSM 20 ml
 53MOTMD20CA LIMPIA CARENADOS MOTO 20ML
 53MOTMD20CAS LIMPIA CASCOS MOTO 20ml



52222015
REPELENTE LLUVIA 300 ml



02QUIXX 10
QUITARAYAS QUIXX SOBRE PINTURA



02QUIXX 20
QUITARAYAS SERAPOL SOBRE PLASTICO



02QUIXX 30
RESTAURADOR FAROS QUIXX



06RP08007
BICOMPONENTE NEGRO 50 ml



06SA03023
MINI KIT REPARACION Q-BOND



06ST03013
 APAREJO METAL GRIS OSCURO 500 ml
 06ST27007
 APAREJO SPRAY GRIS MEDIO 400 ml
 06ST27012
 APAREJO SPRAY GRIS CLARO 400ml,
 06ST27015
 APAREJO SPRAY GRIS OSCURO 400 ml,



06012064
 POLIURETANO CARTUCHO 5001 FC
 06012341
 IMPRIMACION 538 PLUS 100 ml
 06012404
 IMPRIMACION 538 PLUS 30 ml
 0612118A
 KIT PEGAMENTO LUNAS 310 ml
 0612120A
 KIT PEGAMENT LUNA ALIGERADO 501 FC
 05AP100
 BOLSA 100 ISOPOS



05AC0439
 KIT RESTAURADOR OPTICA MAGNA SHINE



TRASERAS

- 32PCT300 - DIMENSION:300mm/12"
- 32PCTB300 - DIMENSION:300mm/12"
- 32PCT350 - DIMENSION:350mm/12"
- 32PCT400 - DIMENSION:400mm/12"
- 32PCTB400 - DIMENSION:400mm/12"



FLAT SERIES - ESCOBILLA FLEX

- 32PCF350 - DIMENSION: 14"/350
- 32PCF380 - DIMENSION: 15"/380
- 32PCF410 - DIMENSION: 15"/410
- 32PCF450 - DIMENSION: 18"/450
- 32PCF480 - DIMENSION: 19"/480
- 32PCF510 - DIMENSION: 20"/510
- 32PCF530 - DIMENSION: 21"/530
- 32PCF550 - DIMENSION: 22"/550
- 32PCF610 - DIMENSION: 24"/610
- 32PCF660 - DIMENSION: 26"/660
- 32PCF710 - DIMENSION: 28"/710
- 32PCF760 - DIMENSION: 30"/760
- 32PCF810 - DIMENSION: 32"/810



ESCOBILLA FLEX

REF. 3852394	280 MM BL 1U	REF. 3852402	400 MM BL 1U
REF. 3852395	300 MM BL 1U	REF. 3852403	510 MM BL 1U
REF. 3852396	330 MM BL 1U	REF. 3852404	530 MM BL 1U
REF. 3852397	350 MM BL 1U	REF. 3852405	560 MM BL 1U
REF. 3852398	380 MM BL 1U	REF. 3852406	610 MM BL 1U
REF. 3852399	410 MM BL 1U	REF. 3852407	660 MM BL 1U
REF. 3852400	430 MM BL 1U	REF. 3852408	710 MM BL 1U
REF. 3852401	450 MM BL 1U	REF. 3852409	760 MM BL 1U



MATRÍCULAS DE ALUMINIO Y ACRÍLICAS

MATRÍCULAS DOBLES		
Referencia		Descripción
100-SE		Matricula ordinaria larga europea 520x110
101-SE		Matricula ordinaria alta europea 340x220
102-SE		Matricula ordinaria larga delantera europea 340x110
103-SE		Matricula ordinaria motocicleta europea 220x160
122-SE		Matricula ordinaria motocicleta corta europea 132x96
124-S		Matricula ordinaria vehiculo especial larga 340x110
104-S		Matricula vehículo especial 280x200
105-S		Matricula remolque y semi-remolque larga 520x110
106-S		Matricula remolque y semi-remolque alta 340x220
107-S		Matricula ciclomotor 100x168



MATRÍCULAS DE ALUMINIO Y ACRÍLICAS

MATRICULAS DOBLES		
Referencia		Descripción
108-S	CD 85 69	Matricula Cuerpo Diplomático 520x110
109-S	01 56 98	Matricula Organizacion Internacional 520 x 110
110-S	CC 20 58	Matricula Cuerpo Consular 520x110
111-S	TA 06 35	Matricula personal Técnico Administrativo 520x110
112-S	T 1520 DSC	Matricula turística larga 520x110
113-S	T 2598 DSC	Matricula turística alta 340x220
114-S	H 2563 JUK	Matricula vehículo histórico larga 520x110
115-S	H 2563 JUK	Matricula vehículo histórico alta 340x220
103-S	H 2563 JUK	Matricula motocicleta histórica 220x160
116-S	P 2158 TMP	Matricula temporal particular larga 520x110

























MATRÍCULAS DE ALUMINIO Y ACRÍLICAS

MATRÍCULAS DOBLES		
Referencia		Descripción
117-S		Matricula temporal particular alta 280x200
118-S		Matricula temporal particular ciclomotor 100 x 168
119-S		Matricula temporal empresa larga 520x110
120-S		Matricula temporal empresa alta 280x200
121-S		Matricula temporal empresa ciclomotor 100x168
123-S		Matricula ordinaria cuatriciclo ligero 210x85





SEÑALIZACIÓN

Señal	Referencia		Descripción
V-4	3001		Discos Limitación Velocidad 20, Ø 200
V-4	3002		Discos Limitación Velocidad 25, Ø 200
V-4	3003		Discos Limitación Velocidad 30, Ø 200
V-4	3035		Discos Limitación Velocidad 35, Ø 200
V-4	3004		Discos Limitación Velocidad 40, Ø 200
V-4	3008		Discos Limitación Velocidad 45, Ø 100
V-4	3009		Discos Limitación Velocidad 50, Ø 200
V-4	3010		Discos Limitación Velocidad 60, Ø 200
V-4	3005		Discos Limitación Velocidad 70, Ø 200
V-4	3006		Discos Limitación Velocidad 80, Ø 200
V-4	3007		Discos Limitación Velocidad 90, Ø 200

SEÑALIZACIÓN			
Señal	Referencia		Descripción
V-5	2018		Triángulo Vehículo Lento
V-6	2012		Vehículo largo (trasera) 1300 x 250
V-6	2013		Vehículo largo (trasera) 500 x 250
V-6	2014		Vehículo largo (trasera) 565 x 200
V-6	2015		Vehículo largo (trasera) 1130 x 200
V-6	2023		Vehículo largo (trasera) 285 x 200
V-6	2025		Vehículo largo (trasera) 565 x 140
V-9	2003		S.P. 150 x 75
V-9	2004		S.P. 225 x 120
V-11	2019		Mercancía peligrosa plegable
V-12			Placa de ensayo o investigación 187,5 x 100 / 150 x 75
V-13	2016 / 2017		Conductor Novel -L con ventosa / bolsa



SEÑALIZACIÓN			
Señal	Señal	Señal	Señal
V-14	2017-R		Conductor Novel -L prácticas rojo
V-14	2017-B		Conductor Novel -L prácticas azul
V-23			Distintivo vehículos de transporte de mercancías 55mm x 50m, para caja rígida
V-23			Distintivo vehículos de transporte de mercancías 50mm x 50m, para caja con lona
AV	105-OV		Placa Animales Vivos 520 x 110
AV	105-OV2		Placa Animales Vivos 340 x 220



SEÑALIZACIÓN			
Señal	Ref.	Imagen	Descripción
V-21	2032		Cartel Avisador Especial Sin Luz
V-21	2031		Cartel Avisador Especial Con Luz
V-22	2029		Cartel Avisador Ciclista Sin Luz
V-24	125-E		Grúa de servicio de auxilio en carretera
V-20	2011		Carga Sobresaliente de Vehículo 500x500



48167051 TULIPA ROTATIVO ALTA
 48A141 ROTATIVO FIJO 12V
 48A151 ROTATIVO FIJO 24 V
 48167066 ROTATIVO PINCHO 12 V (A 121)



48167065 ROTATIVO PINCHO 24V (A531)
 48167068 ROTAT. MAGNETICO 12V (561)
 48167069 ROTAT. MAGNETICO 24V (571)
 48167067 ROTAT. PINCHO FLEX. 12V (601)



48167070
 ROTATIVO CARRETILLA 12-24V(215)
 482144HF
 ROTAT. FLEXIB. 12V ELLIPSE (TIPO SETA)



47167005
 3ª LUZ DE FRENO 1 LAMPARA (837)
 47167009
 3ª LUZ DE FRENO 3 LAMPARAS



TORNILLOS ANTIROBO RUEDA
VER APLICACION PARA CADA
VEHICULO



CINTURONES DE SEGURIDAD
VER TABLA DE APLICACIONES

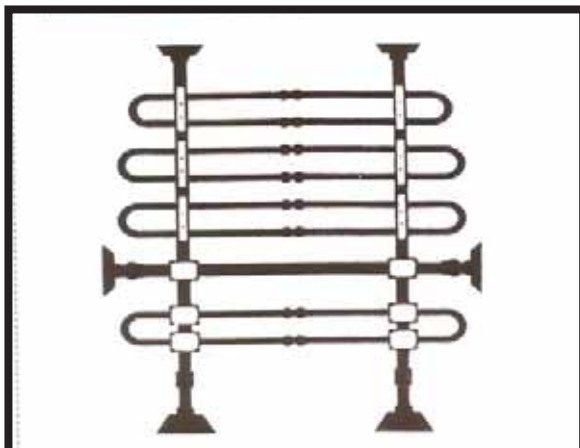

49588615
SEPARADOR CARGA MINI 116-160CM
49588616
SEPARADOR CARGA MAXI 156-210 CM ,

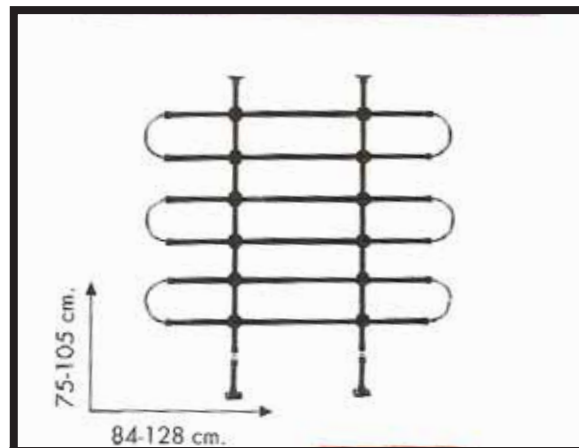

2016099
SEPARADOR PERROS 3 BARRAS

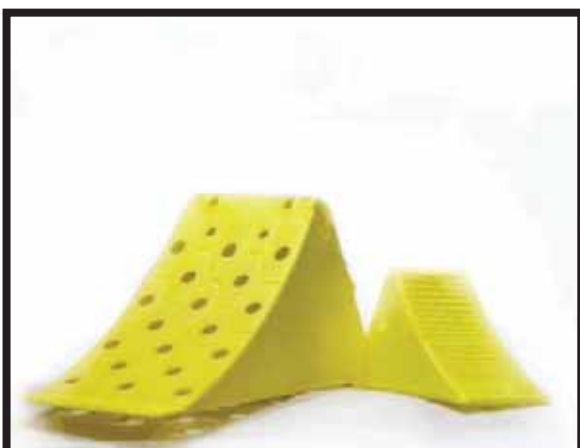

34027020 CALZO CAMION
34027021 CALZO TURISMO



28152527
TAPONES HERMETICOS ACEITE



49210010 PORTA MONEDAS ALUMINIO
49210011 PORTA MONEDAS PLASTICO
49210012 PORTA MONEDAS PARA TAXI
CAJA

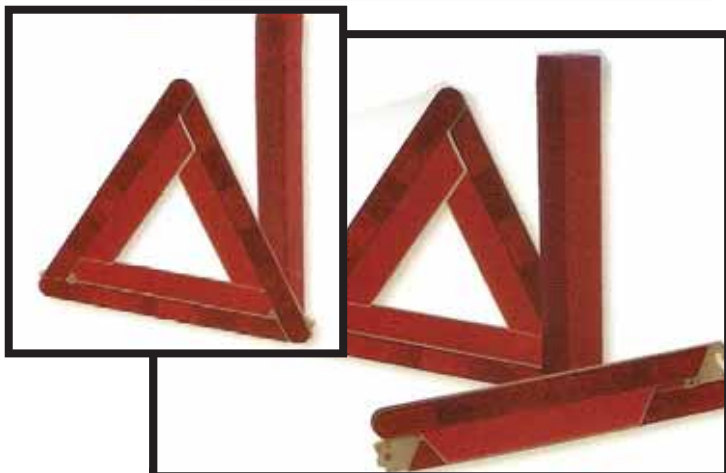

TRIANGULOS HOMOLOGADOS :
JUEGO DE 1 UNIDAD
JUEGO DE 2 UNIDADES



79620030 / 79620031
CHALECO REFLECTANTE AMARILLO



48M0005
CABEZA ENGANCHE EM 750KG C60mm
48M00093
RUEDA 4.00-4.80
48M00113
CABEZA ENGANCHE EM 750 KG C50mm
48M00120
RUEDA JOCKEY D.48 200X50
48M00121
BRIDA RUEDA JOCKEY D48mm
48M00390
BOLA MONOBLOCK
48M00392
BOLA FIJA M 20X50mm + TUERCA



PROTECTOR PARAGOLPES
 023210195 PLATA 4U
 023210200 NEGRO
 023210225 TRANSPARENTE 2U



02PRK2000
 PROTECTOR GARAJE ESQUINAS 2 U
 02PRK3000
 PROTECTOR GARAJE PARED 20X33X40 1U



02AIRSTGR
 FILTRO AIRE DEPORTIVO VERDE
 02AIRSTRN
 FILTRO AIRE DEPORTIVO GRIS
 02BZA60PK
 FILTRO AIRE DEPORTIVO PINK



02BZA56BL
 CINTA DECORATIVA LLANTAS AZUL
 02BZA56RD
 CINTA DECORATIVA LLANTAS ROJO
 02BZA56SV
 CINTA DECORATIVA LLANTAS PLATA
 02BZA56WT
 CINTA DECORATIVA LLANTAS BLANCA



48175005
 TIRAS PULPO PLANA 100 cm



ESTRELLAS MERCEDES
 VARIOS MODELOS



34DTPG7 COMPROBADOR DIGITAL AIRE
+ PROFUNDIMETRO
34015162 KIT REPARAPINCHAZOS
34015208 CORDON REPARAPINCHAZOS
TURISMO CAJA 50U
34015281 CORDON REPARAPINCHAZOS
CAMION 5U



1450604003
KIT REPARAPINCHAZOS 1U



02SLIMCAR
KITREPARAPINHAZOS COMPRESOR
MAS SELLANTE



02VULCANO
COMPRESOR PROVESIONAL 12V



022202007
GATO CARRETILLA 2TN



023505137
ARRANCADOR 12V 900 AMP



1450607001
LLAVE RUEDA FIJA 17-19-21-23



1450607003
LLAVE RUEDA ACODADA EXTENSIBLE
17-19-21-23



CINTA DOBLE CARA
47CDC0009 9X10
47CDC1012 12X10
47CDC1019 19X10



FLEXOMETROS. 3 Y 5 m.



33FA7 PORTATIL CABLE PVC 7mts
33FA PORTATIL SIN CABLE

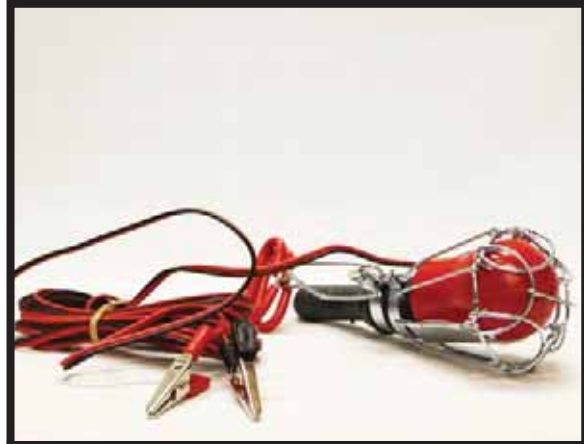

33FP4 PORTATIL BATERIA 4mts
33FP8 PORTATIL BATERIA 8 mts



33026004 LINTERNA FRONTAL 14
LED SG7011



33026005 PORTATIL TRABAJO
22LEDS LS2132



REF. 34167002
LINTERNA SIN PILAS, CON DINAMO





REF. 6440300

PROLONGADOR ANTENA 100 CM



REF. 6440301

PROLONGADOR ANTENA 350 CM



REF. 6440302

PROLONGADOR ANTENA 450 CM



REF. 6440330

ADAPTADOR DE ANTENA



REF. 6440331

ENCHUFE DE ANTENA 58MM



REF. 6440280

ANTENA ELECTRONIC. AUTOMATC.
DE-LUXE
12V



REF. 6440210
ANTENA TELESC.
100CM- 0/30°



REF. 6540211
ANTENA TELESC.
100CM- 21°



REF. 6440220
ANTEN. A TETTO
55CM



REF. 6440221
ANTEN. A TETTO
40CM



REF. 6440265
ANTENA A TETTO
AERO-FIN-1
ALTURA 4,5 CM



REF. 6465657
COPPIA BROCHE
COPRIOFORO
22MM



REF. 6440266
ANTENA A TETTO
AERO-FIN-2 ALTU-
RA 5 CM



REF. 6440333
ADAPTADOR
PARA ANTENA
AM-FM



REF. 6402496 TITANIO

REF. 6402497 AZUL

REF. 6402498 ROJO

TAPONES VÁLVULAS.
BL. 4 UNIDADES



REF. 6402500 TITANIO

REF. 6402501 AZUL

REF. 6402502 ROJO

TAPONES VALVULAS OVALADOS .
BL 4UNIDAES.



REF. 6402503 ALUM.

REF. 6402504 AZUL

TAPONES CROMADOS ALUM. . BL 4UD



REF. 6474101

ROTULADOR BLANCO NEUMAT.
10050



REF. 6460193

TIRAS PULPO ALTA RESISTENCIA
18MM 80 CM

REF. 6460213

TIRAS PULPO ALTA RESISTENCIA
18MM 150CM



REF. 6460166

PRO-SAFE, SET 2 NASTRI TENSORI CON CRICCHETTO A DOPPIO GANCIO "S"
CM 500 LARGHEZZA NASTRO 2,5CM 125 daN



REF. 6460167

PRO-SAFE, SET 2 NASTRI TENSORI CON CRICCHETTO A DOPPIO GANCIO "S"
CM 500 LARGHEZZA NASTRO 3,5CM 400 daN

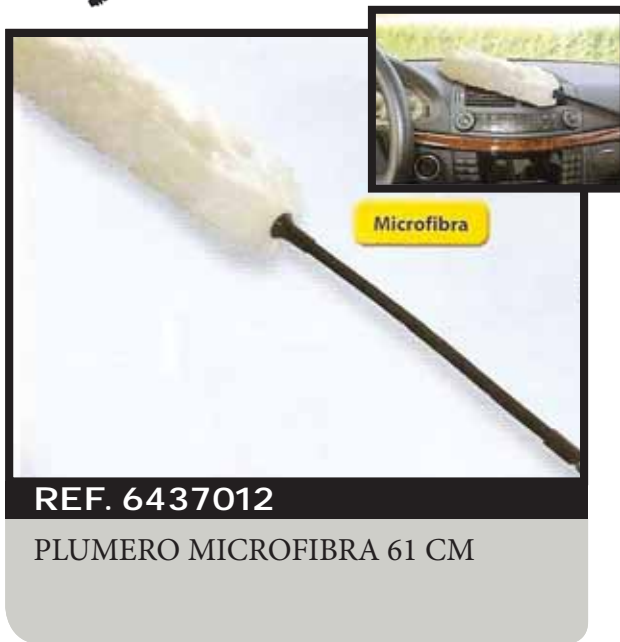

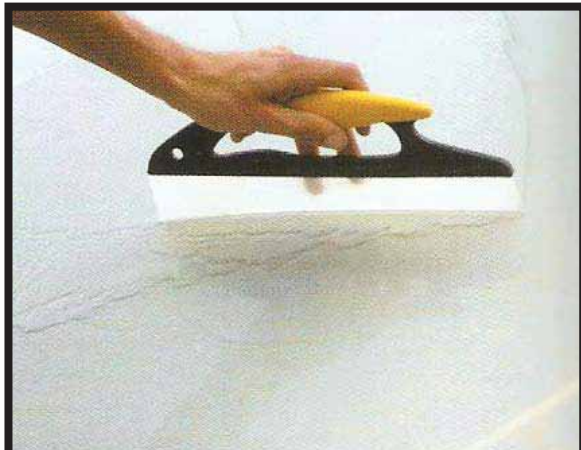

REF. 6437385

WHIPE-DRY
ESPÁTULA



REF. 6472132

SPIROX 2 EN 1. ASPIRAPOLVERE
ASPIRALIQUIDI E SOFFIATORE
12V 75W



REF. 6472130

BIDONE ASPIRAPOLVERE.
4 ACCESSORIOS.
12V 160W

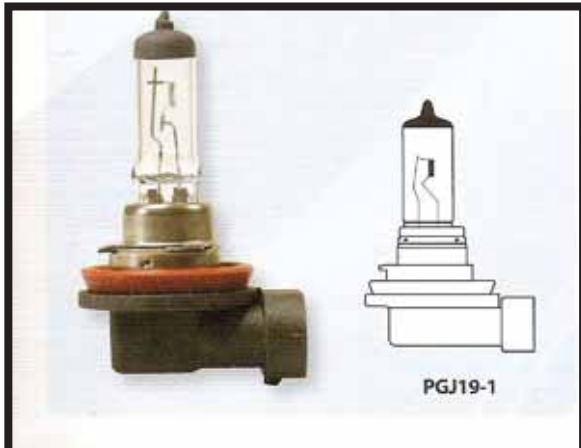

REF. 6457940

LAMAPARA HALOGENA
H8 12V 35W



REF. 6457950

LAMAPARA HALOGENA
H9 12V 65W

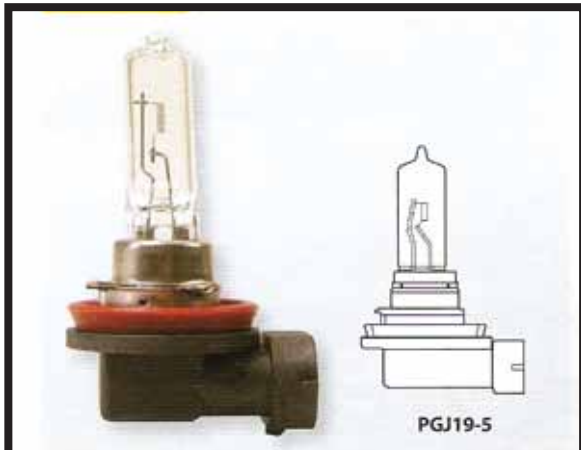

REF. 6457951

LAMAPARA HALOGENA
H9 65W PGJ19

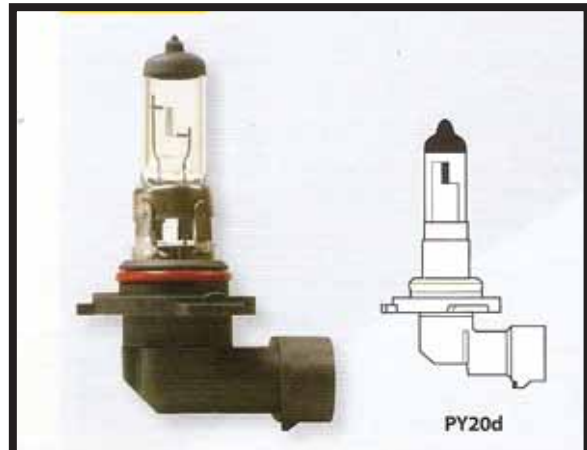

REF. 6457960

LAMAPARA HALOGENA
H10 12V 42W

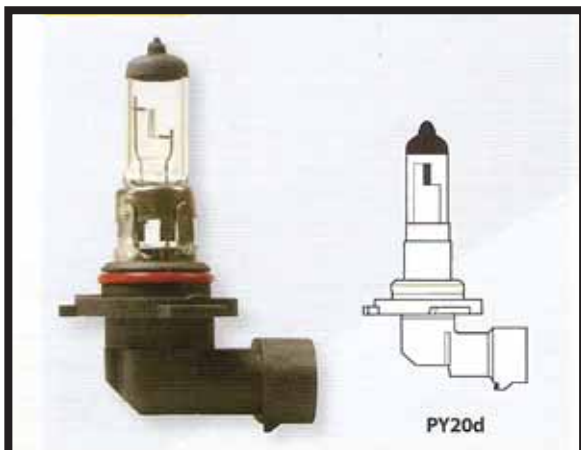

REF. 6457961

LAMAPARA HALOGENA
H10 42W PY20D

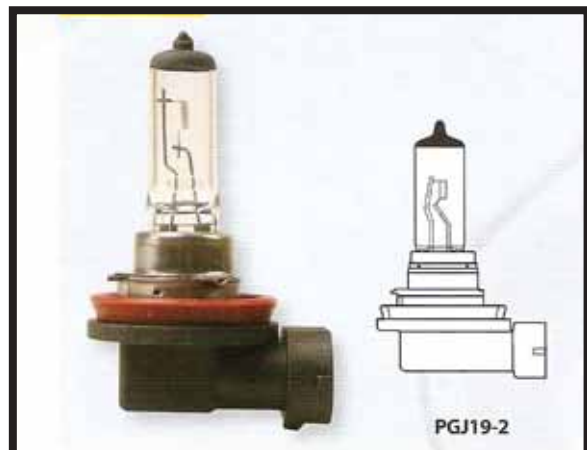

REF. 6457970

LAMAPARA HALOGENA
H11 12V 55W

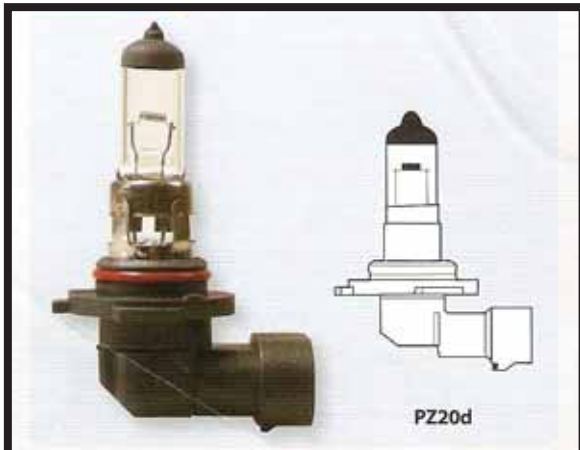

REF. 6457980

LAMPARA HALOGENA
H12 12V 53W



REF. 6458000

LAMPARA FOCO EUROPEO
12V



REF. 6458010

LAMPARA H1 12V 55W
BLISTER



REF. 6458012

LAMPARA HALOGENA
H1 12V 2PCS



REF. 6458030

LAMPARA H3 12V 55W



REF. 6458040

LAMPARA H4 12V 60-55W

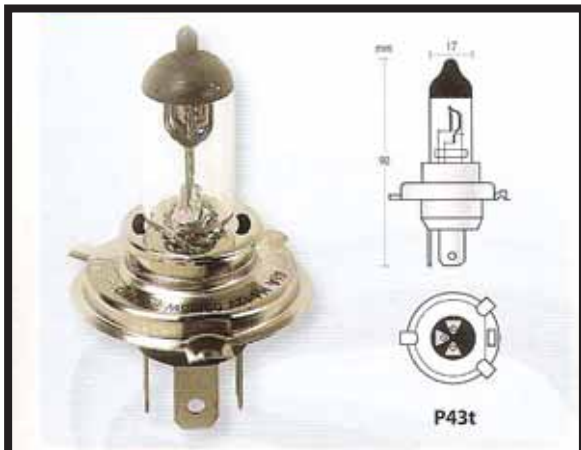

REF. 6458043

LAMPARA H4 12V 60-55W
BLISTER 2P



REF. 6458050

LAMPARA HALOG.
H5 60-55W



REF. 6458053

LAMPARA H7 12V 55W



REF. 6458057

LAMPARA H7 12V 55W
CLEAR DBLS

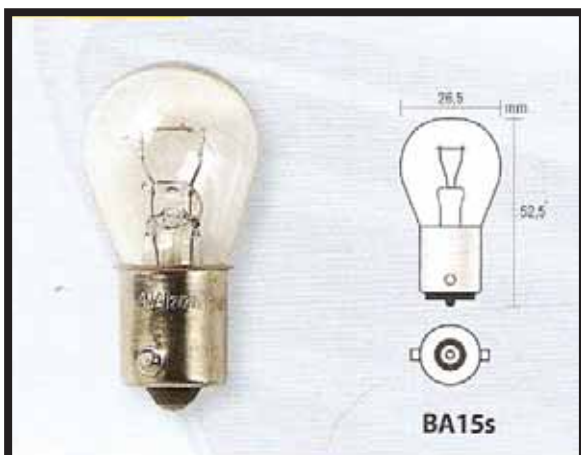

REF. 6458060

LAMPARA BLX2
12V 21W BA15S

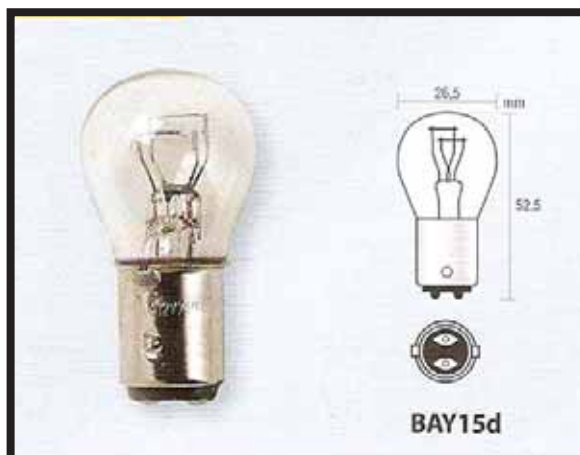

REF. 6458062

LAMPARA BLX2
12V 215W 2FIL

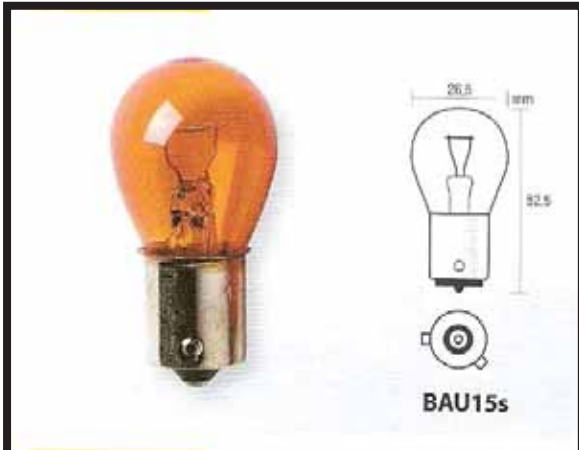

REF. 6458065

LAMPARA BLX2
12W 21W AMBAR



REF. 6458070

LAMPARA BLX2 PILOTO
12V R5W



REF. 6458071

LAMPARA
R10W BA15S 2 PCS

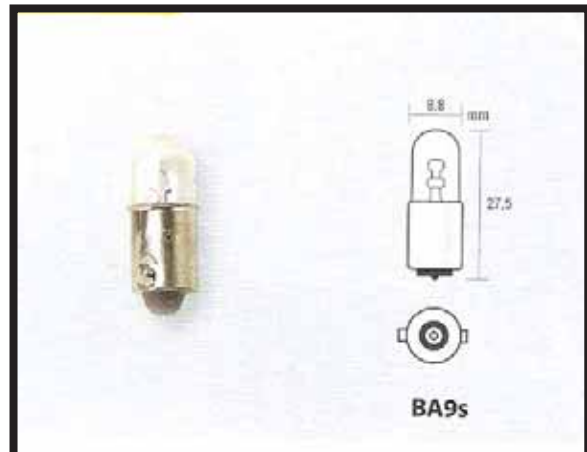

REF. 6458080

LAMPARA
BLX2 12V MICRO T4W CC

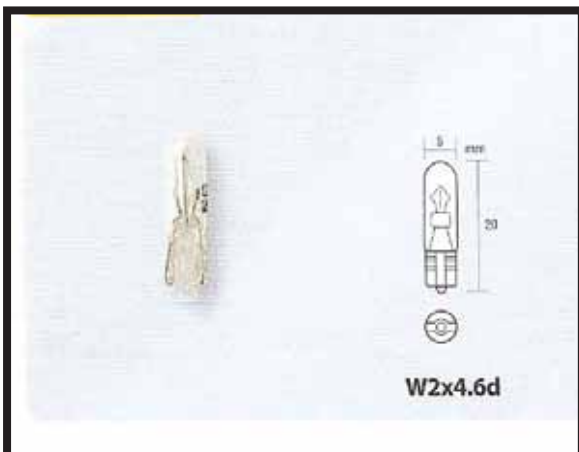

REF. 6458092

LAMPARA WEDGE BASE
1,2W T5

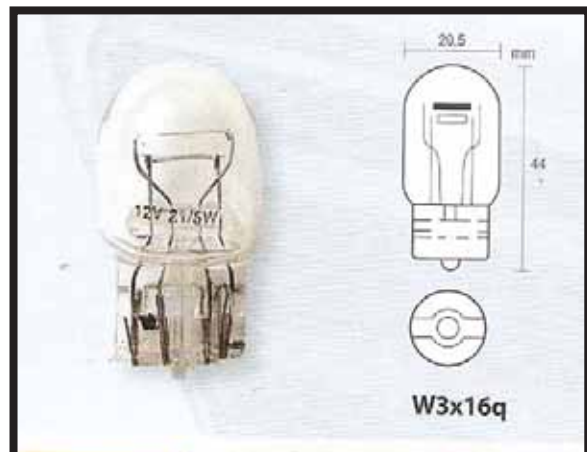

REF. 6458096

LAMPARA
12V 215W SCASQ BLI2P

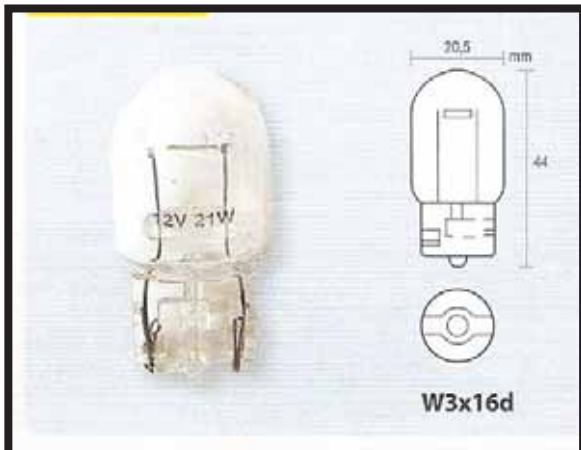

REF. 6458097

LAMPARA
12V 21W 3X16D

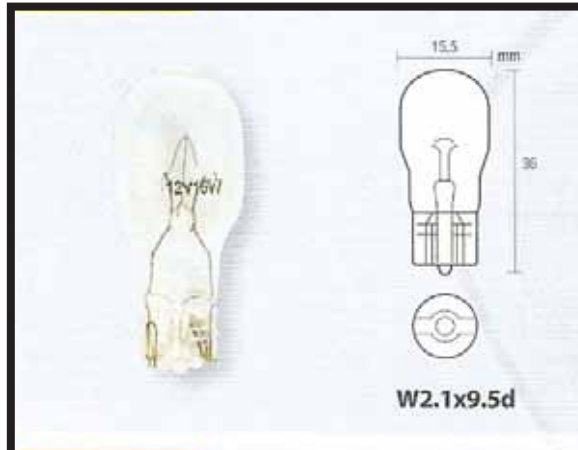

REF. 6458099

LAMPARA
12V 16W



REF. 6458100

LAMPARA
12V WY21W NARANJA

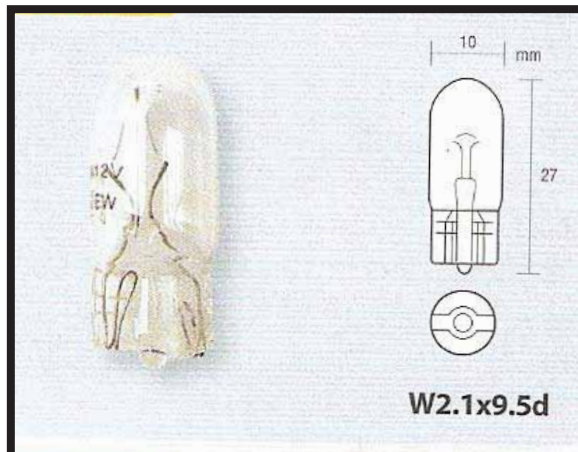

REF. 6458105

LAMPARA
12V 5W SCASQUI BLX2

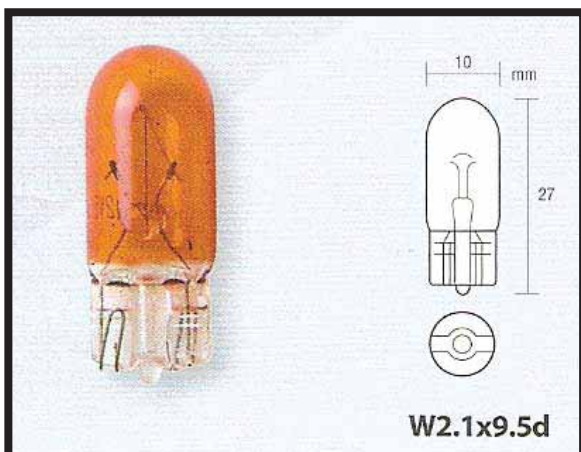

REF. 6458106

LAMPARA
12V 5W SCASQUI AMBAR. B2

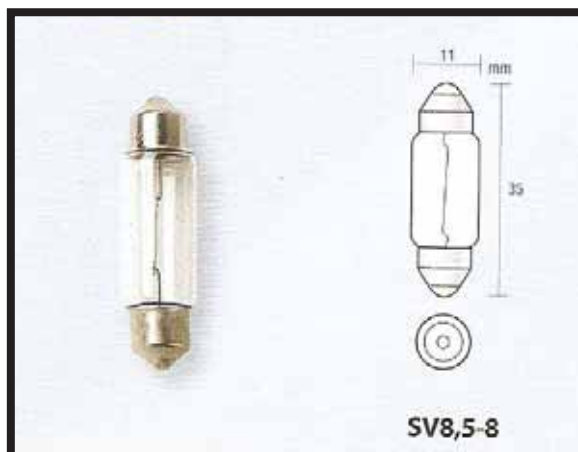

REF. 6458110

LAMPARA TORPEDO
12V C5W

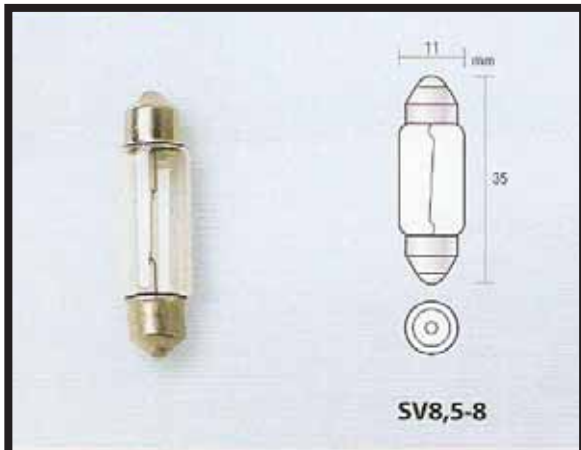

REF. 6458111
LAMPARA PLAFÓN
10W SV8,5 11X38MM

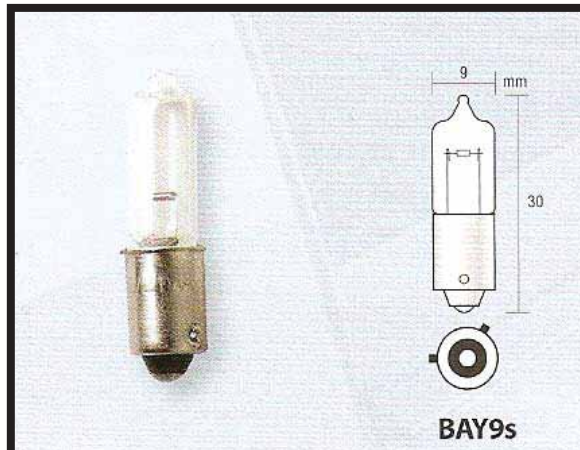

REF. 6458121
LAMPARA
12V H21W BLISTER 2P

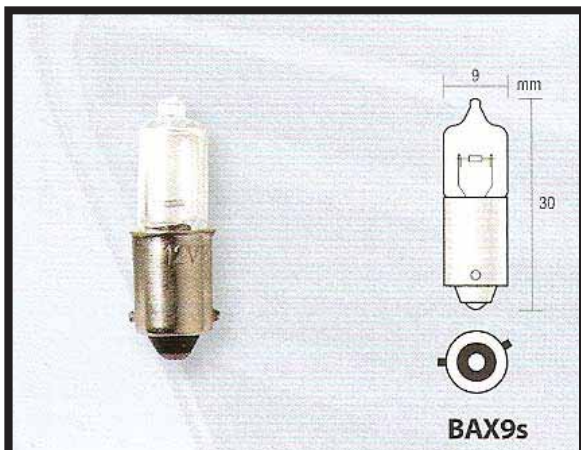

REF. 6458128
LAMPARA
12V H6W BLISTER 2P

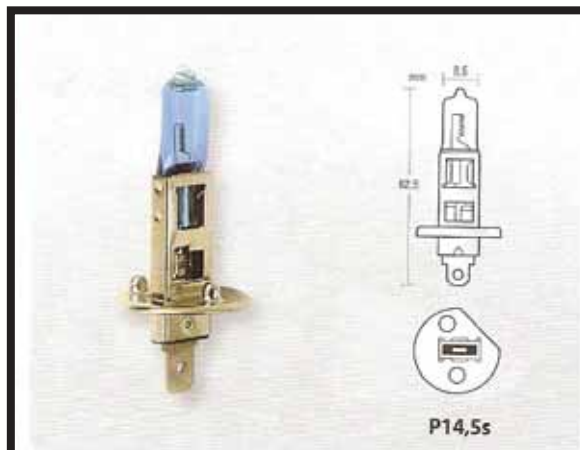

REF. 6458180
LAMPARA BLUE-XENON
H1 12V 55W

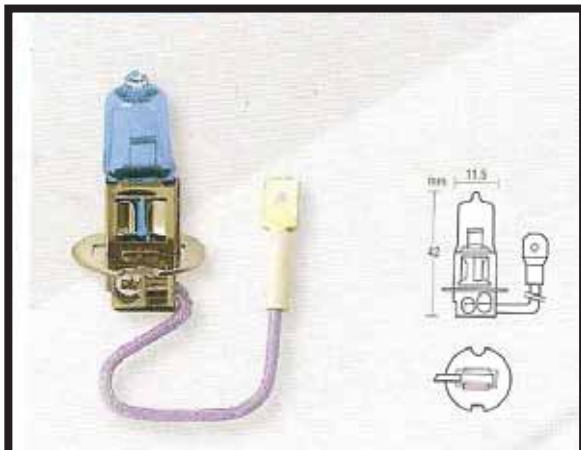

REF. 6458182
LAMPARA BLUE-XENON
H3 12V 55W

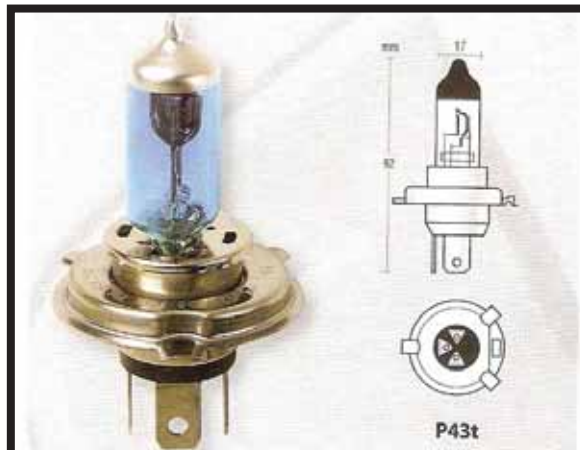

REF. 6458184
LAMPARA BLUE-XENON
H4 12V 60-55W
2U



REF. 6458161

ESTUCHE LAMPARAS
H1 12V 19PCS

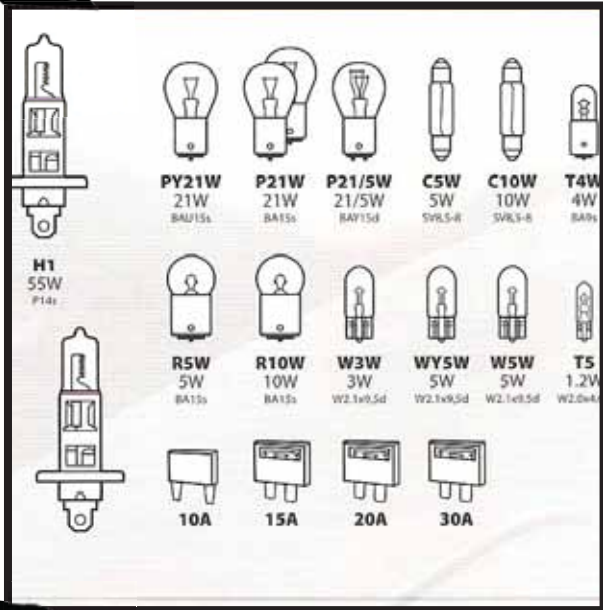

REF. 6458163

ESTUCHE LAMPARAS
H4 12V 15 LAMP + 4FUS

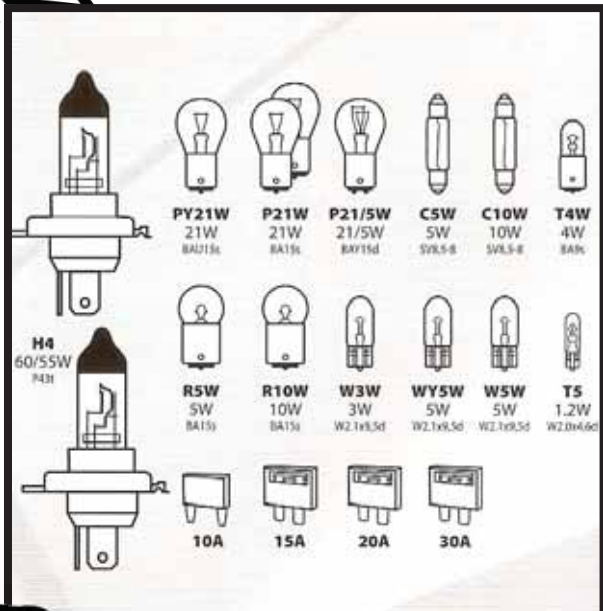

REF. 6458162

ESTUCHE LAMPARAS
H7 12V 15 LAMP+4FUS

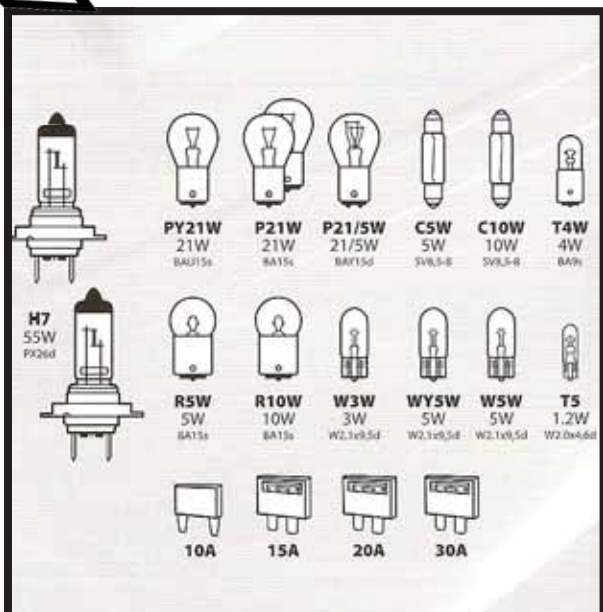

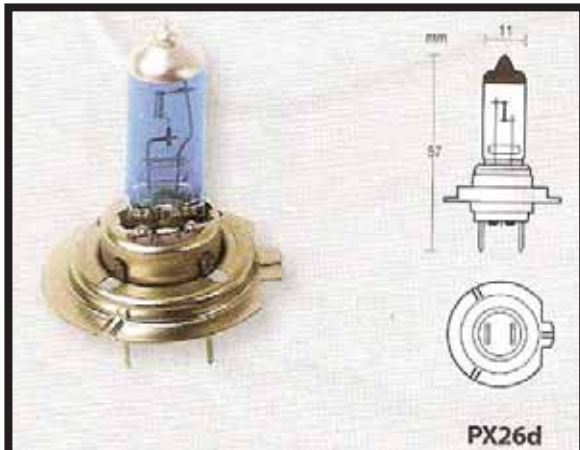

REF. 6458186

LAMPARA BLUE-XENON
H7 12V 55W
2P

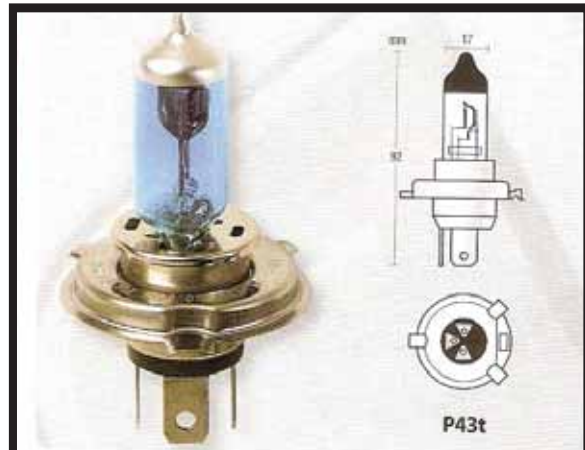

REF. 6458194

LAMPARA BLUE-XENON
H4 12V
BLX2



REF. 6458196

LAMPARA BLUE-XENON
H7 12V 55W
BLX2

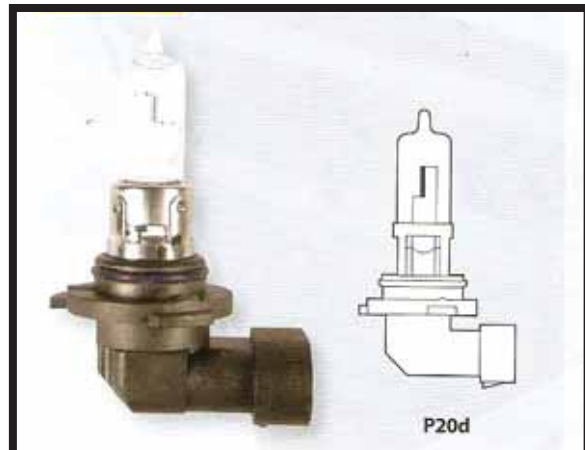

REF. 6458275

LAMPARA
HB39005 65W 12V

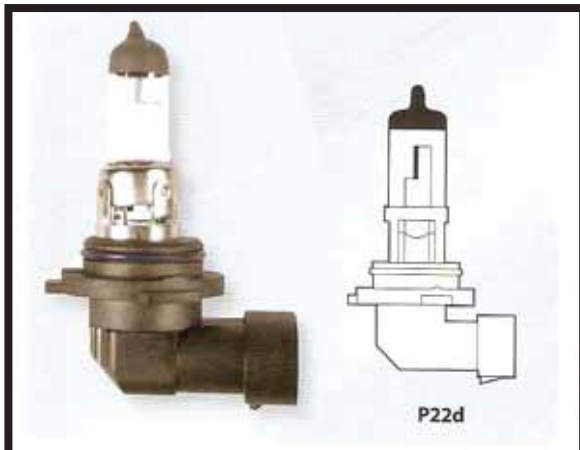

REF. 6458280

LAMPARA
HB49006 55W 12V

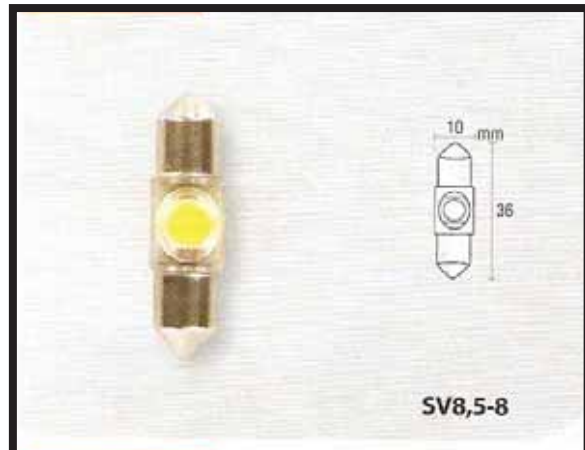

REF. 6458448

LAMPARA
12V 10W C5 HYPER LED



W2.1x9.5d

REF. 6458454

LAMPARA
12V 5W T10 SMDX3CHI.
BL2



REF. 6498310 24V 21W 12LED
REF. 6498312 24V BAU15S AMB
REF. 6498318 24V BAY15D

LAMPARA LED

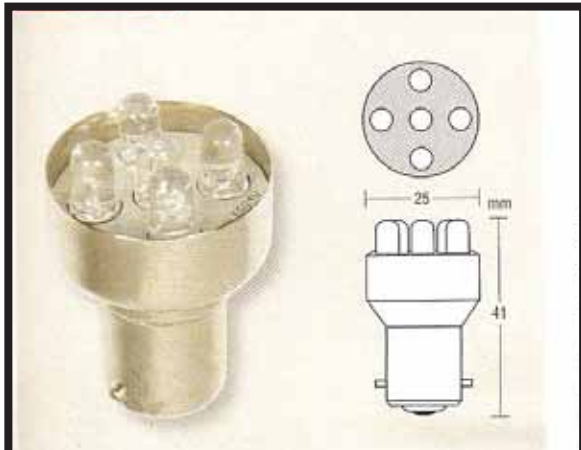

REF. 6498314

LAMPARA BLANCA
24V 5 LEDS



REF. 6458447

HYPER LED POWER 2
10X31MM 12V - (C5-10W)
1PZ



REF. 6458448

HYPER LED POWER 2
10X36 MM 12V - (C5-10W)
1PZ



REF. 6458449

HYPER LED POWER 4
10X42 MM 12V - (C5-10W)
1PZ



REF. 6458453

HYPER LED POWER 2
12V - (T10)
2 PZ

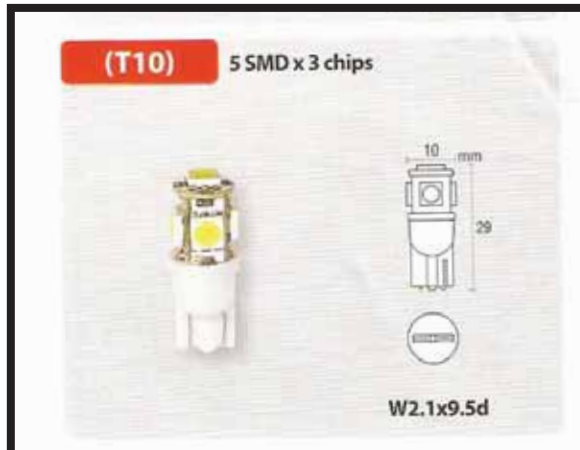

REF. 6458454

HYPER LED POWER 15
12V - (T10)
2 PZ



REF. 6458455

HYPER LED POWER 27
12V - (T10)
2 PZ



REF. 6458456

HYPER LED POWER 39
12V - (T10)
2 PZ



REF. 6458460

HYPER LED POWER 6 BIFOCUS
12V
2 PZ



REF. 6458461

HYPER LED POWER 6 BIFOCUS
12V - (T10)
2 PZ

(T10) 3 SMD x 3 chips

10 mm
28
W2.1x9.5d

REF. 6458462

HYPER LED POWER 9 TRIFOCUS
12V - (T10)
2 PZ

(T5) 1 SMD x 2 chips

W2x4.6d

REF. 6458465 BLANCO
REF. 6458466 AZUL
REF. 6458467 ROJO

HYPER LED POWER 2
12V - (T5)
2 PZ

12
70

REF. 6458510

HYPER LED 39
H1 - 12V
BLANCO 2PZ -13 SMD x 3CHIPS - P14,5s

16
65

REF. 6458513

HYPER LED 54
H4 - 12V
BLANCO 2PZ -18 SMD x 3CHIPS - P143t

16
50

REF. 6458512

HYPER LED 54
H7 - 12V
BLANCO 2PZ 18 SMD x 3CHIPS - PX26d



REF. 6458259

LÁMPARA XENON
D2R 4300K



REF. 6458257

LÁMPARA XENON
D1S 4300K



REF. 6458258

LAMPARA XENON
D2S 4300K



REF. 6454500 MARRÓN CLARO Y OSCURO

REF. 6454497 GRIS CLARO Y OSCURO

SAMURAI
SCHIENALE IN PALLINE DI LEGNO



REF. 6454354 NEGRO

REF. 6454355 GRIS

BAMBÚ, SCHIENALE ESTIVO IN FIBRA NATURALE DI BAMBÚ CON SOPPORTO LUMBARE



REF. 6454247

ROYAL, SCHIENALE A MOLLE IN FIBRA NATURALE DI CELLULOSA.
1 PZ. COLOR GRIS



REF. 6454395

MASSAGE VELLUTO SCHIENALE MAGNETICO
NEGRO



REF. 6454317 MÀRFIL

REF. 6454319 NEGRO

EVOLUCIONE
SCHIENALE IN PALLIENE DI LEGNO



REF. 6454356 azul

REF. 6454357 Rojo

BAMBÚ
EN FIBRA NATURAL DE BMBÚ



REF. 6454466 AZUL

REF. 6454467 NARANJA

REF. 6454468 AMARILLO

REF. 6454469 MORADO

REF. 6454470 BURDEOS

FASHION FRESH
HECHO EN FIBRA NATURAL DE
BAMBÚ

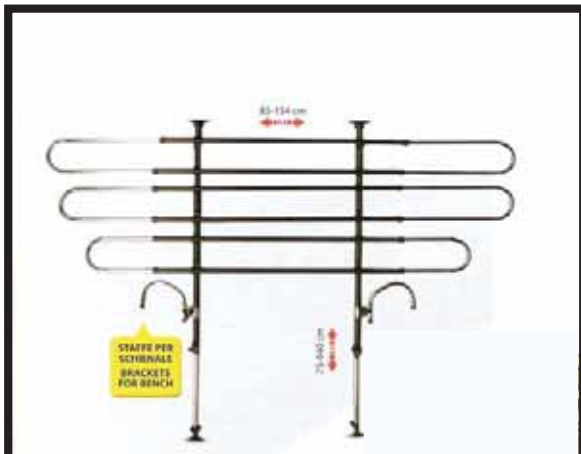

REF. 6460414

DOG CARGO GUARD,
GRIGLIA DIVISORIA.
TELESC. 3 ELEMENTI



REF. 6460415

SEPARATORE TELESCOPICO A 2
ELEMENTI.



REF. 6460416

DOG CARGO GUARD,
GRIGLIA DIVISORIA
IN RETE METALICA, TELESCOPICA





REF. 6460399

PROTECTOR ASIENTO TRASERO
PARA PERROS



REF. 6460408 M

REF. 6460409 L

DOGGY BELT, IMBRACATURA PER
CANI



REF. 6460400

RED PROTECTORA PERROS
120X50CM



REF. 6460402

RED MALETERO PERROS
130X87CM



REF. 6469959

ORGANIZADOR MALETERO
72X25X14.5 CM



REF. 6469948 80X25 CM

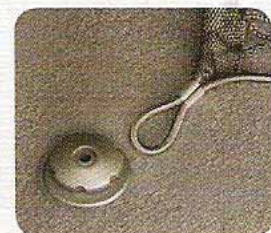

REF. 6469949 90X35 CM
MALLA PORTAOBJETOS MALETERO
DISTINTAS MEDIDAS



REF. 6400126

GT
ALEACIÓN DE ALUMINIO Y PIEL



REF. 6400190

TOURING
ALEACIÓN DE ALUMINIO Y PIEL



REF. 6400112

EXCLUSIVE PLC-6
PIEL, REDONDO



REF. 6405001

CUFFIA LEVA CAMBIO. NEGRO
IN VERA PELLE.
MISURA UNIVERSAL

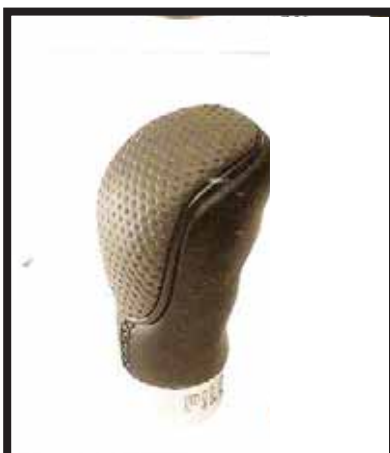

REF. 6400091

MITO.
ALUMINIO Y PIEL



REF. 6400110

EXCLUSIVE PLC-8
PIEL, ANATÓMICO



REF. 6400137

POWER BALL, POME-
LLO VOLANTE
IN VERA PELLE



80x60 mm

Regolabile Adjustable

REF. 646556
ESPEJO INTERIOR SEGURIDAD
80X60



135x68 mm

REF. 646555
ESPEJO PANORAMICO INTERIOR
CONV. 135X68MM



REF. 6466846 70X130
REF. 6466847 80X140
PARASOL DIAMANT REFLEX
DISTINTAS MEDIDAS



Seta di poliestere Polyester silk

REF. 6466911
MOLLY, COPPIA TENDINE A MOLLA
IN SETA DI POLIESTERE NERA
35X45CM



REF. 6466918
MOLLY POSTERIORE,
TENDINA A MOLLA. 50X100 CM
POLIESTER NEGRO CON VENTOSA



Filtro solare Sun filter

Parasole Sunvisor

Filtro abitaco Air filter

REF. 6466913
ECLIPSE 3 EN 1.
COPPIA TENDINE PARASOLE
55X45CM



REF. 6466916

MOLLY, CONTOUR SUNBLOCK
COPPIA TENDINE A MOLLA
NYLON NEGRO 45X65CM



REF. 6466917

MOLLY SUNBLOCK,
COPIA TENDINE A MOLLA
NYLON NEGRO 35X45CM



CORTINILLA TRASERA TRAP
DISTINTAS MEDIDAS

REF. 6466671 100 CM

REF. 6466681 110 CM

REF. 6466691 120 CM



REF. 6424020

COVER, TAPPETO PER BAULE.
PRODOTTO IN PVC ATOSSICO RESISTENTE.
120X80 CM



REF. 6426162

DUOBLO, TAPPETINO DUOBLIFACE
34X47 CM



REF. 6426185

TAPPETINO TRAY-MAT
44X55 CM



REF. 6424803

RALLY COPIA TAPPETI ANTERIORI.
IN GOMMA.
70X51 CM



REF. 6424810

TAPPETINO RALLY
RETRO ANTISCIVOLO
40X 49 CM



REF. 6424011 v-1 90X50cm

REF. 6424012 v-2 90X70cm

REF. 6424013 v-4 90X85cm

REF. 6424014 v-2 90X100cm
PROTEUS ANTISCIVOLO



REF. 6424804

INDI, COPPIA TAPPETI ANTERIORI.
IN GOMA.
69X48 CM



REF. 6426806

CONTOUR, SERIE TAPPETI UNIVER-
SALI 4 PEZZI. IN GOMMA.

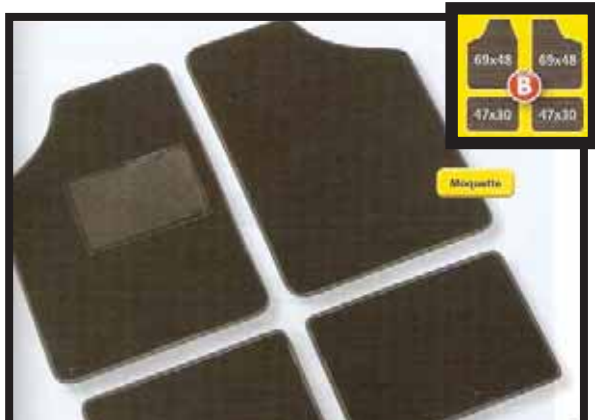

REF. 6426851 NEGRO
REF. 6426854 ANTHRACITA

SUPRA, SERIE TAPPETI 4 PZ.
 EN MOQUETA
 100% PROLIPROPILENE LAVABLE



REF. 6426905 Negro
REF. 6426908 beige

JUEGO DE ALFOMBRAS DE GOMA
 LAMPA
 72X49MM 45X46MM



REF. 6426906 NG

ALADINO, SERIE TAPPETI
 UNIVERSAL 4 PZ.
 (2u)72x50 + (2u) 43x50

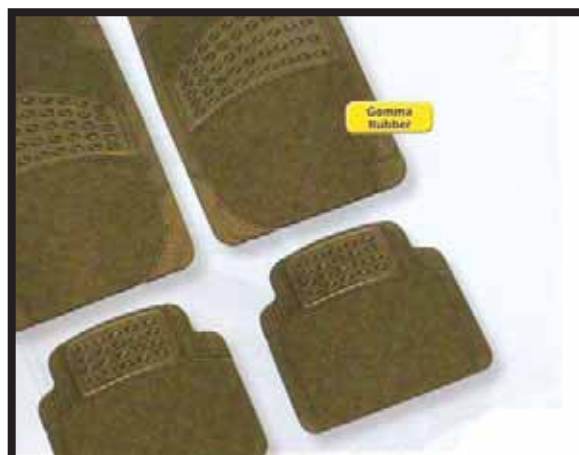

REF. 6426910 BEIGE

ALADINO, SERIE TAPPETI
 UNIVERSAL 4 PZ.
 (2u)45x70 + (2u) 43x45



REF. 6426810

CLEAR
 SERIE TAPPETI TRANSPARETI
 4PZ



REF. 6433115 **negro**

REF. 6433116 **negro-gris**

FUNDA VOLANTE CLUB
NEGRO 35X37CM



REF. 6433066 **negro**

REF. 6433067 **negro gris**

FUNDA VOLANTE CLUB NEGRO
37X39CM



REF. 6498575 **46-48**

REF. 6498574 **44-46**

FUNDA VOLANTE
RADICA



REF. 6498585 **42-44**

FUNDA VOLANTE
SEMI-PIEL



REF. 6498846 **44-46**

FUNDA VOLANTE CA-
MIÓN NG



REF. 6433020

JUMBO-FANT, COPRIVOLANTE
UNIVERSALE CON LACCIO
SPESSORE 4,5MM LARG.87 MM



REF. 6433050

ELEFANT, COPRIVOLANTE
UNIVERSALE CON LACCIO
SPESSORE 2,5MM LARG. 87 MM



REF. 646595

SET 8 PZ. CHIAVI ESAGONALI
MASCHIO



REF. 646601

SET 8 PZ. CHIAVI ESAGONALI TIPO
TORX

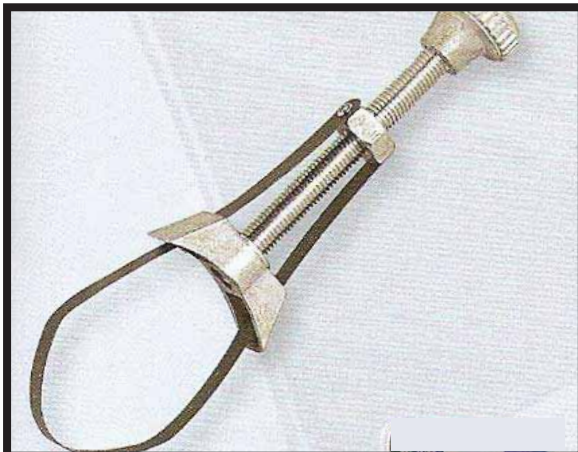

REF. 6474152

LLAVE DE FILTROS DE FLEJE



REF. 6474153

LLAVE DE FILTRO CADENA



REF. 6470156

FILTRO CARBURANTE
TRANSPARENTE



REF. 6465902

LLAVE TAPÓN CARTER
8-10MM

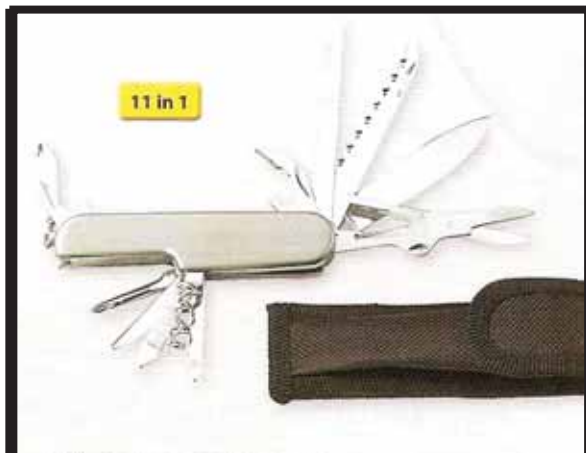

REF. 6466142

NAVAJA SUPERVIVENCIA 11EN1



REF. 6466141

ALICATE MULTIUSOS + FUNDA



REF. 6465932

LLAVE DE HILADO ROTANTE



REF. 6465992

CACCIAVITE A "T"
9 CHIAVI A BUSSOLA E 11 INSERTI
INTERCAMBIABILI



REF. 6465931

MULTIPLICADOR DE FUERZA PARA
COCHE Y FURGONETA



REF. 6470027

PENZA PER CAPICORDA



REF. 6474065

TESTER 6/12V
MULTIUSO, ADATTO PER INDIVIDUARE I FILI ON TENSIONE



REF. 6474081

TESTER ANTIHIELO IN VETRO



REF. 6474080

TESTER ANTIHIELO PROFESIONAL



REF. 6474000

MEDIDOR PRESIÓN NEUMÁTICOS PROFESIONAL



REF. 6474011

PRUEBA PRESIÓN DE NEUMÁTICO DIGITAL



REF. 6474013

PRUEBA PRESIÓN DE NEUMÁTICO DIGITAL

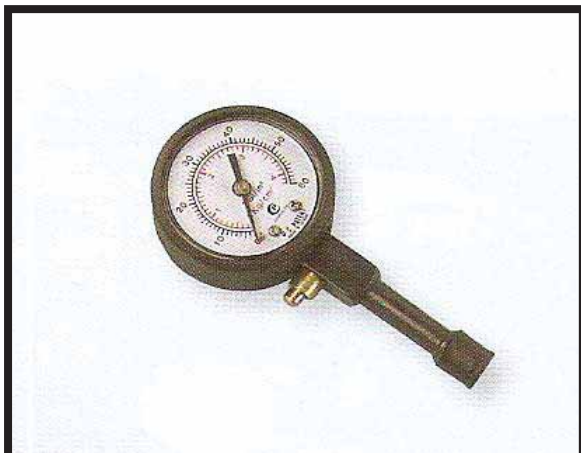

REF. 6474010

MEDIDOR PRESIÓN NEUMÁTICOS.
MAX.60



REF. 6490237

KIT REPARACIÓN PINCHAZOS.



REF. 6472166

PULSE-JET
KIT REPARACIÓN AUTOMÁTIC. AU-
TOMOVIL. 12V



REF. 6472154 (recambio)

REF. 6472153

KIT REPARACIÓN NEUMÁTICO
PUMP & GO



REF. 6471550 2TN

REF. 6471551 5TN

REF. 6471554 10TN

GATO HIDRÁULICO BOTELLA



REF. 6474001

PISTOLA GONFIAGGIO
PNEUMATICI



REF. 6467025

TAPÓN DE EMERGENCIA UNIVERS.



REF. 6472167 450ml

REF. 6472168 600ml

LÍQUIDO SELLADOR PARA NEUMÁTICO



REF. 6465401

ANTIFURTO PER GIUNTO A SFERA UNIVERSAL. 50MM



REF. 6490600

CADENA ANTORROBO VIPER 120CM



REF. 6490607

CADENA ANTIRROBO KITON 120 CM



REF. 6490616

CABLE BLOQUEO DISCO REMINDER

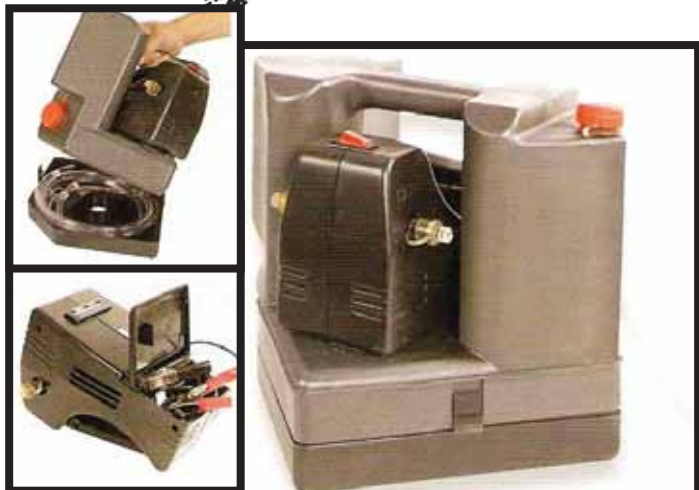

REF. 6472165

KIT POMPA ASPIRAOLIO CON
SERBATOIO DI RACCOLTA
12 V CAPAC. 5L



REF. 6472163

BOMBA EXTRACTORA DE ACEITE
12V



REF. 6471600

BOMBA A PEDAL
1 CILINDRO



REF. 6471610

BOMBA A PEDAL
2 CILINDROS



REF. 6471602

BOMBA A PEDAL ENERGETICA CON
MANOMETRO DE PRESIÓN
1 CILINDRO



REF. 6467030

EMBUDO TRASVASE
CON TUBO FLEXIBLE
DIAMETRO 160 MM



REF. 6467031

SET EMBUDOS. 4 PIEZAS
50-75-100-120 MM

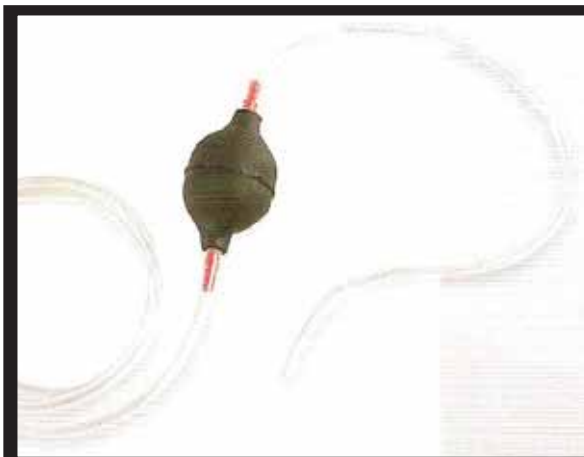

REF. 6438123

POMPA SIFON PROFESIONAL
TUBO 180 CM



REF. 6438121

POMPA SIFON
PARA TRASVASE DE CUALQUIER
LIQUIDO.



REF. 6465906

ECO DEPOSITO CAMBIO ACEITE



REF. 6465905

CUBETA ACEITE 6LITROS.



REF. 6466961

KIT PRIMEROS AUXILIOS (BOLSA)



REF. 6466963

KIT PRIMEROS AUXILIOS (CAJA)



REF. 6420602

JGO TIRAS CROM SALVAPT
570X25MM

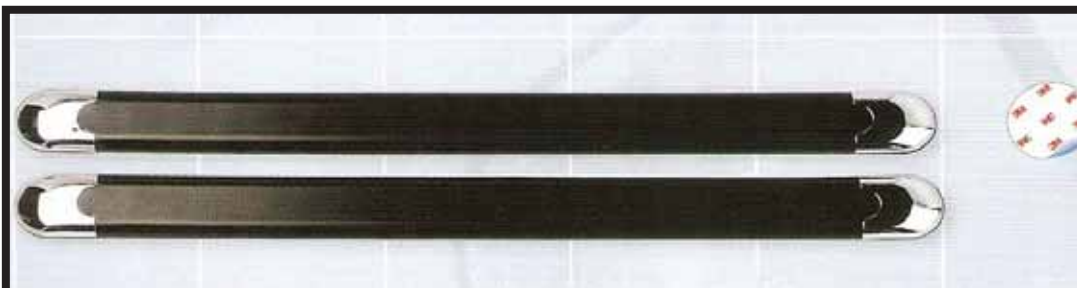

REF. 6420603

JGO PROTEC PARAG CROM
495X40MM



REF. 6420650

PROTECTORES PUERTA CREFLECT.



REF. 6460027

COLA ESCAPE OVALADA
TS-17 45-60MM



REF. 6460031

COLA ESCAPE
TS-19 45-60MM

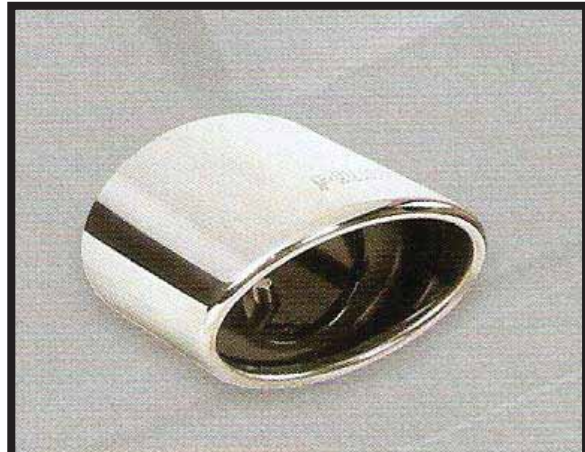

REF. 6460055

COLA ESCAPE OVAL
40-54MM



REF. 6460120

COLA ESCAPE CURVO
T-6 30-45MM



REF. 6460130

COLA ESCAPE
35-57MM



REF. 6465551

ESPEJO ADICIONAL PARA CARAVANA

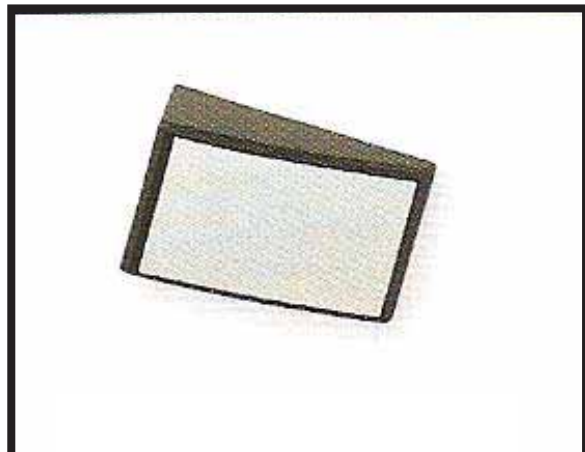

REF. 6465560

ESPEJO ADHESIVO CONVEXO
55X35



REF. 6465561

ESPEJO ADHESIVO CONVEXO
REDONDO



REF. 6465562

ESPEJO ADHESIVO CONVEXO
REDONDO

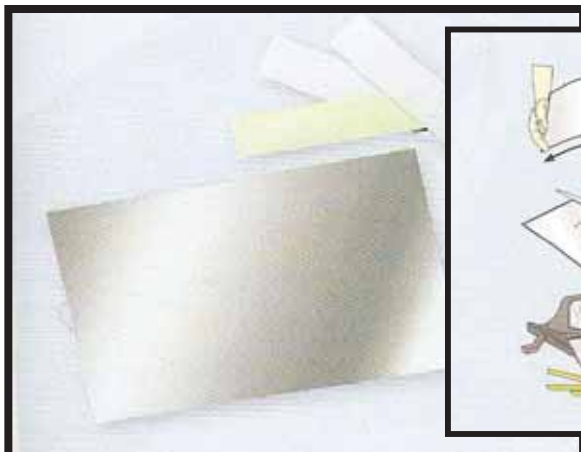

REF. 6465557

ESPEJO MÁGICO MULTIUSOS
127X203MM

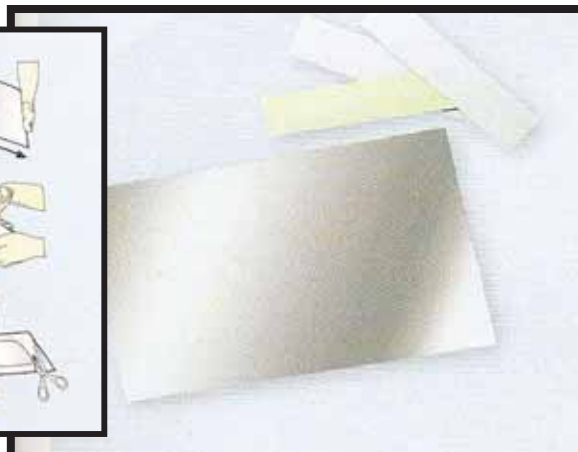
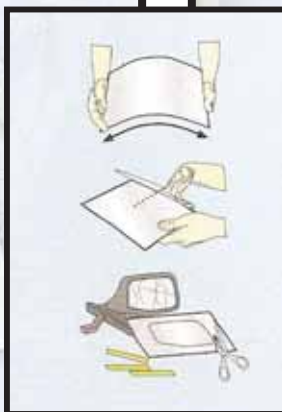

REF. 6465558

ESPEJO MÁGICO MULTIUSOS
253X178MM



REF. 6498705

PARAQUQUES DE GOMA
1 PZ

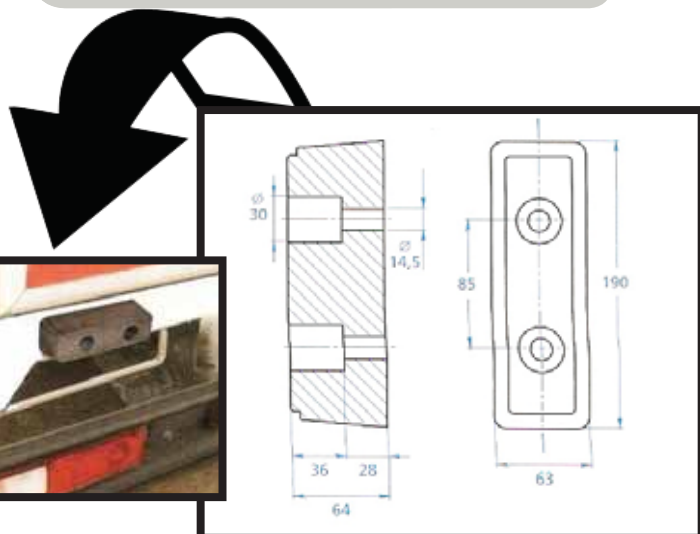



REF. 6412500

COPPIA PARASPRUZZI UNIVERSALI
ANTERIOR Y POSTERIOR CON PVC
22,5X33CM



REF. 6412991

RALLY, COPPIA PARASPRUZZI
ANTERIOR/POSTERIOR
23,5X42,5CM



REF. 6421833

EARTH- STRIP, CINGHIA ANTISTATICA
IN METALLO



REF. 6439045

INTERRUPTOR BATERÍA
61224V 100 AMP



REF. 6439047

ENCHUFE MECHERO 3 TOMAS
1224 V

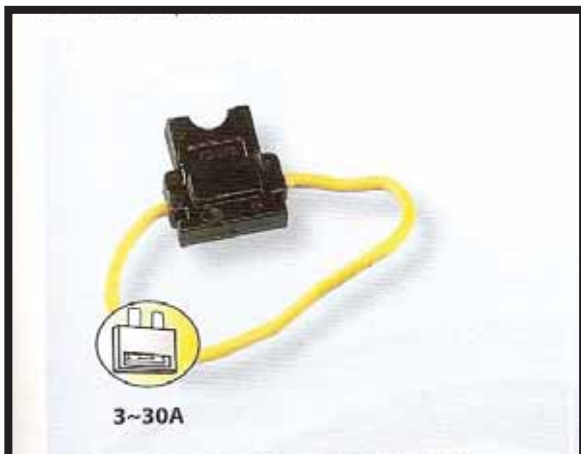

REF. 6445001

PORTAFUSIBLE PF-1 3-30AMP

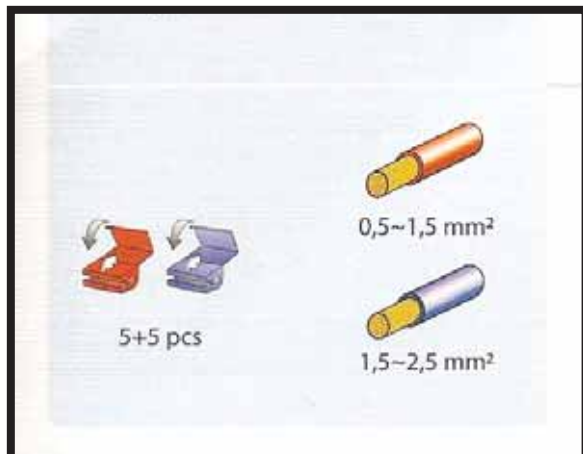

REF. 6445050

CONECTOR MACHO-HEMBRA
5AZ 5RJ

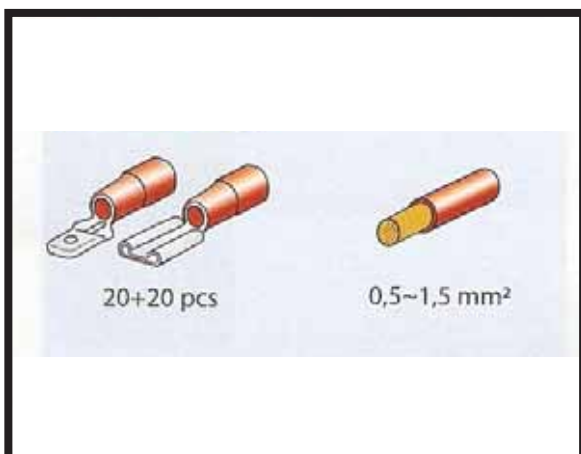

REF. 6445051

KIT 40 TERM RJ 6.3X8
20U + 20 HEM

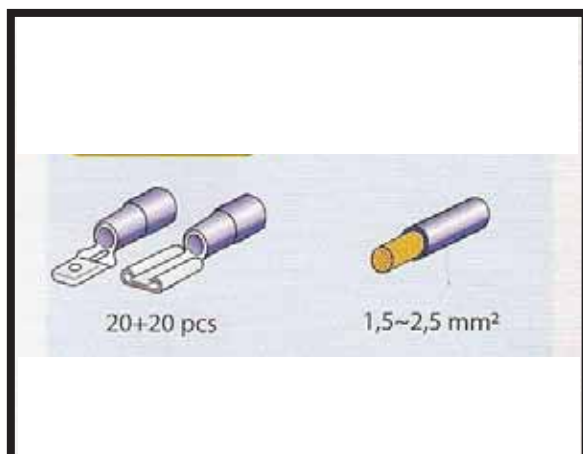

REF. 6445052

KIT 40 TERM AZ 6.3X8
20U + 20 HEM

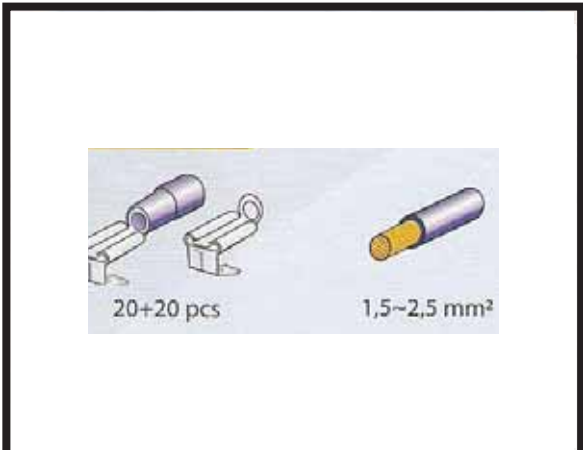

REF. 6445053

KIT 40 TERMINALES 6.3X8MM
AZUL

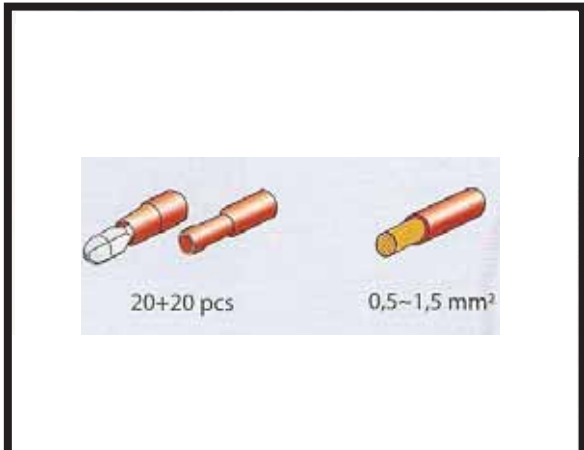

REF. 6445056

KIT 40 TERMINALES 0.5-1.5
RED

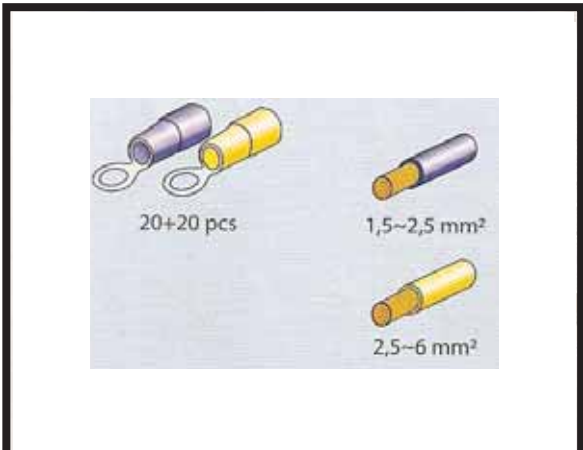

REF. 6445057

KIT 40 TERMINALES INT 56MM
AZ 1.5

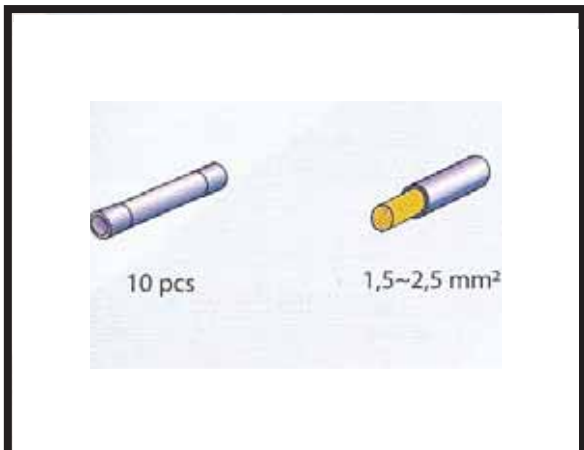

REF. 6445060

CONECTOR A PRESION AZUL
10 UD. 1.5

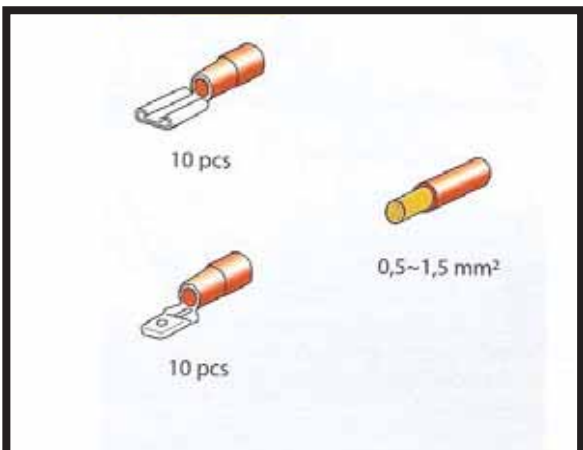

REF. 6445061

TERMINAL HEMBRA ROJO
6.3X8MM 10 PC

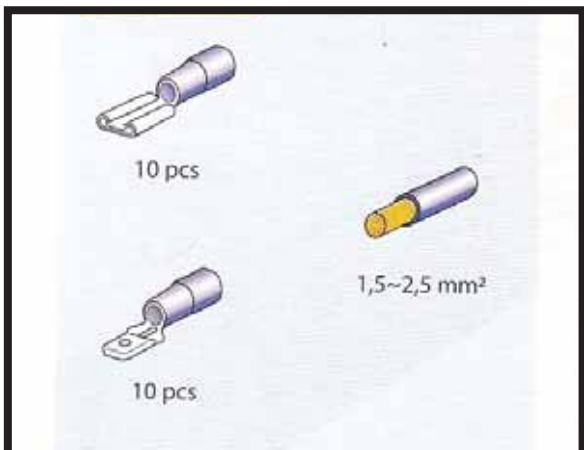

REF. 6445062

TERMINAL HEMBRA AZUL
6.3X8MM 10 PC

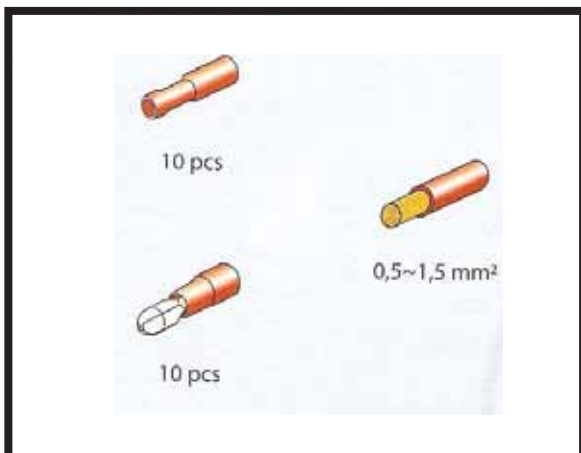

REF. 6445063

TERMINAL HEMBRA ROJO INT
4MM 10 UDS.

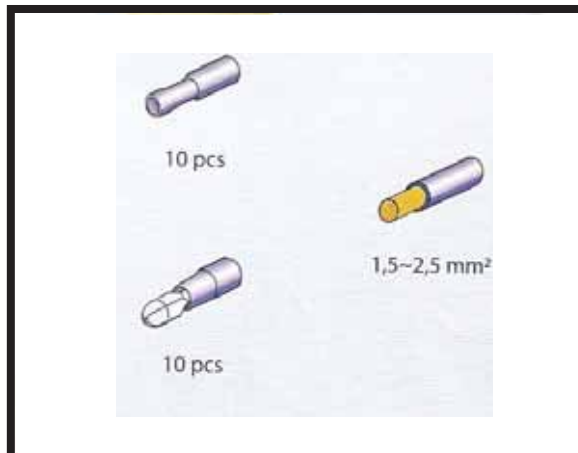

REF. 6445064

JGO TERMINAL RED HEMBRA AZ
1.5 a 2.5

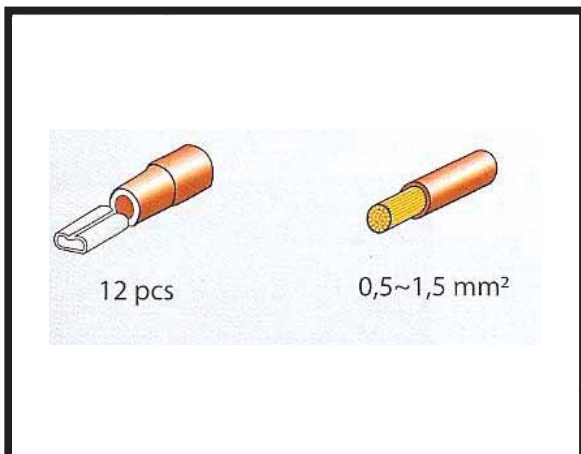

REF. 6445065

TERMINAL HEMBRA RJ 12U 0.5-1.5

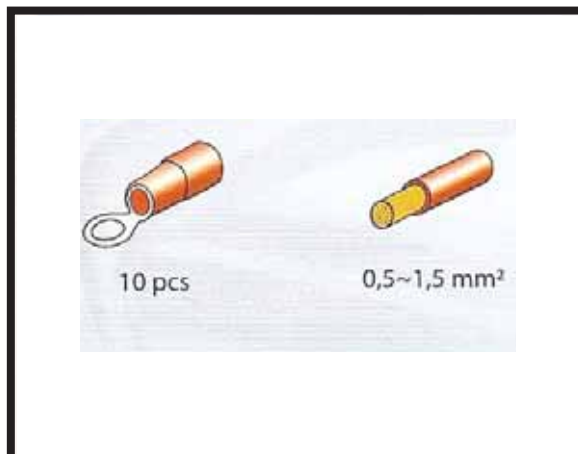

REF. 6445066

TERMINAL INT 5MM RJ
10 UD 0.5

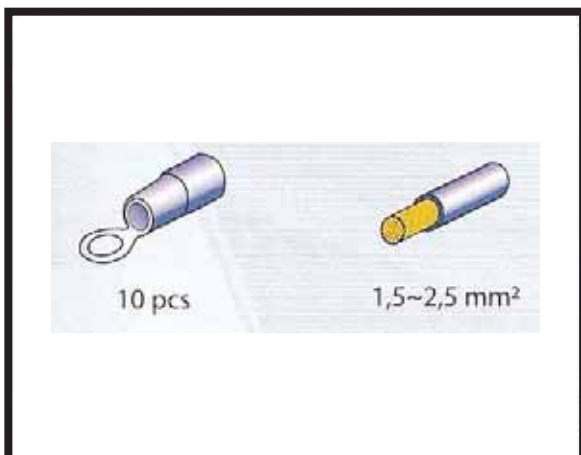

REF. 6445067

TERMINAL INT 5MM AZ
10 UD 1.5

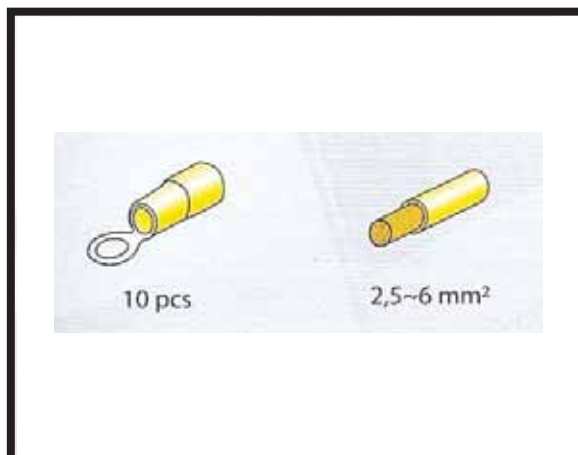

REF. 6445068

TERMINAL INT 5MM AMAR
10 UD 2.5

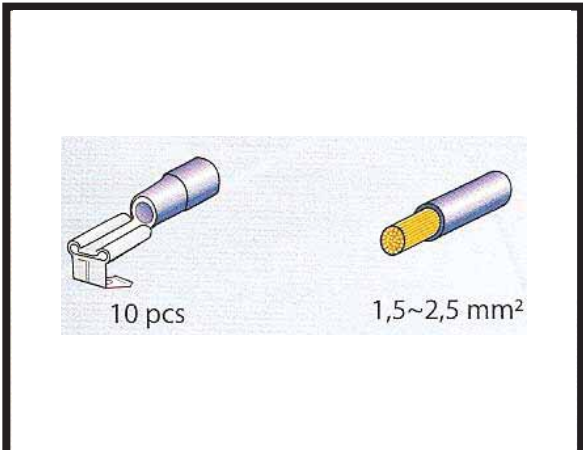

REF. 6445070
 TERMINAL MACHO-HEMBRA
 AZ. 10U.

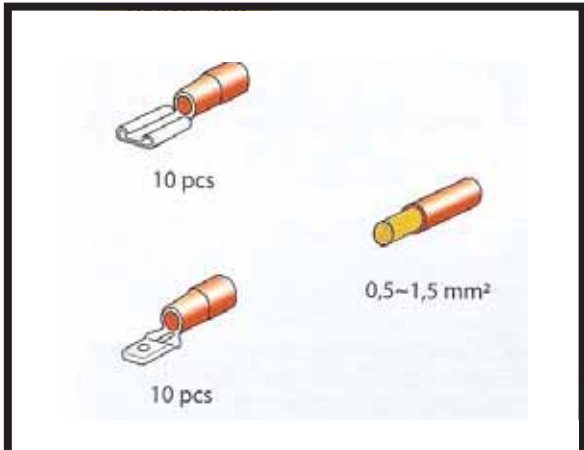

REF. 6445071
 JUEGO TERMINAL MACHO RJ 10 U.
 6.3X8MM

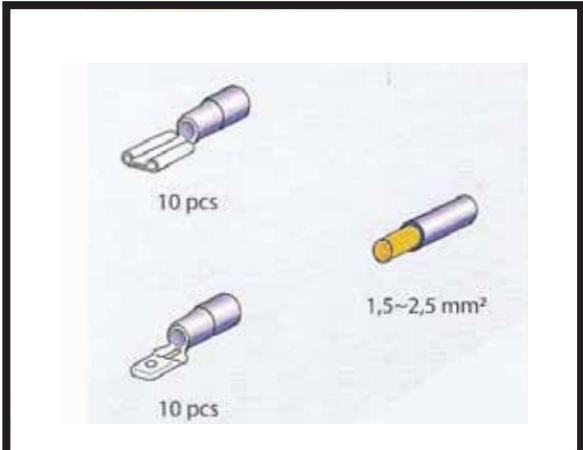

REF. 6445072
 JUEGO TERMINAL AZ. 10U
 6.3X8MM

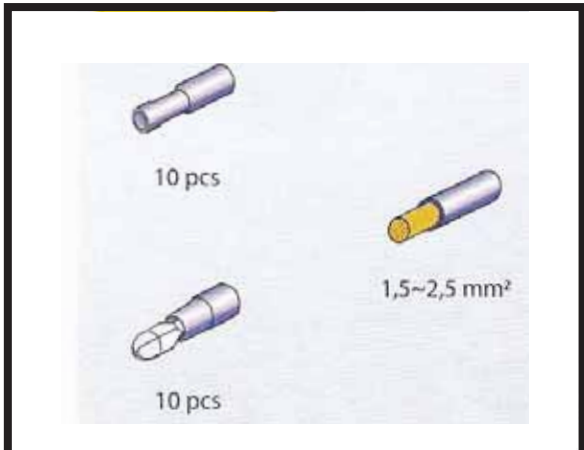

REF. 6445073
 JUEGO TERMINAL RED. MAZHO AZ
 1.5 a 2.5

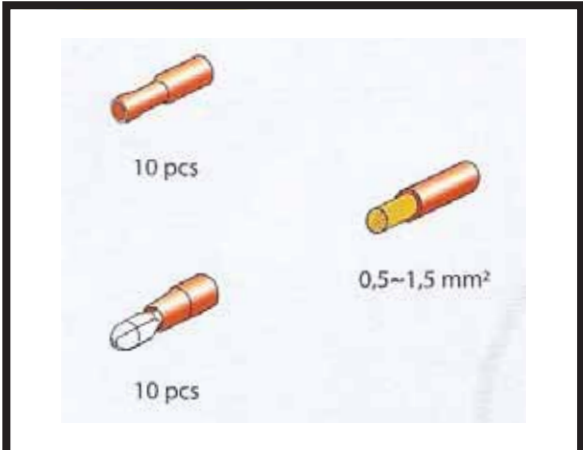

REF. 6445074
 TERMINAL MACHO ROJO INT 10U
 4MM



REF. 6445500
 RELE UNIVERSAL 4 TERM
 12V 30 AMP



REF. 6445501

RELE UNIVERSAL 5 TERM
12V 30 AMP

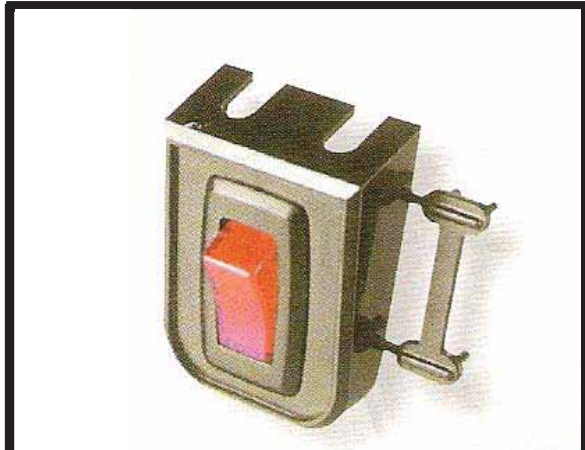

REF. 6445552

INTERRUPTOR LUMINOSO ROJO
12V 30A



REF. 6445553

INTERRUPTOR LUMINOSO ROJO
12V 20A



REF. 6445554

INTERRUPTOR PALANCA LED
3T 12V



REF. 6445580

INDICADOR LED ROJO
1224V



REF. 6470030

BORNES DE BATERIA



REF. 6470040

BORNES BATERIA EURO MODEL

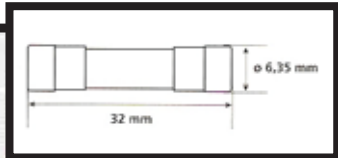
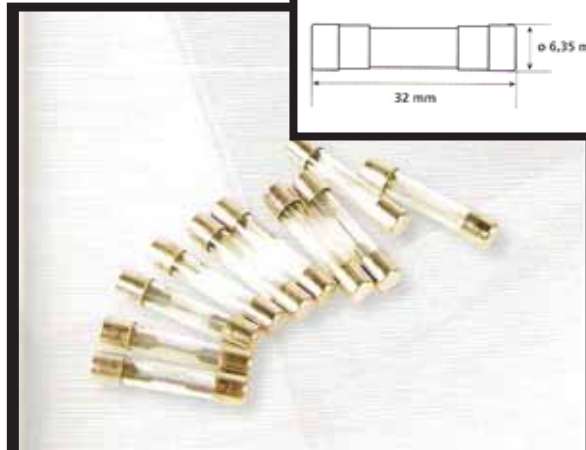

REF. 6470062

JUEGO FUSIBLES VIDRIO GRANDE.

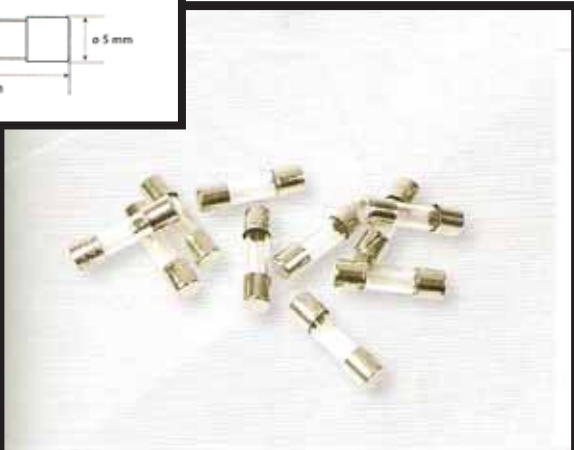
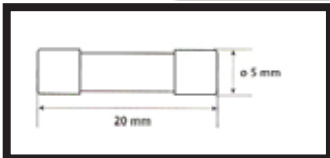

REF. 6470063

JUEGO FUSIBLES VIDRIO PEQUEÑ.

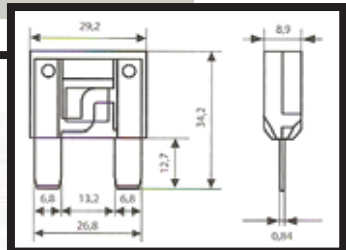

REF. 6470072 20A

REF. 6470073 30A

REF. 6470074 40A

REF. 6470075 50A

REF. 6470077 70A

REF. 6470078 80A

REF. 6470079 100A

FUSIBLE PLANO MAXI

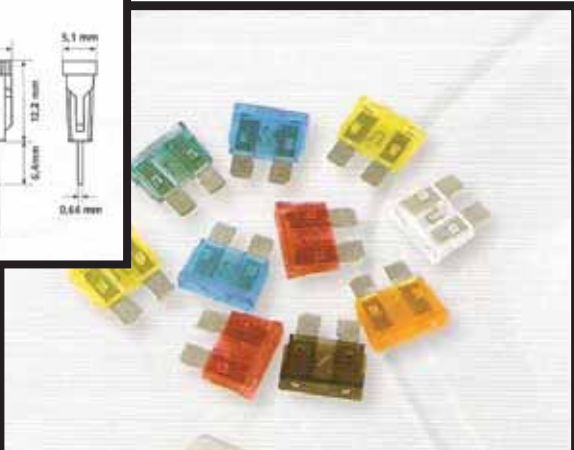
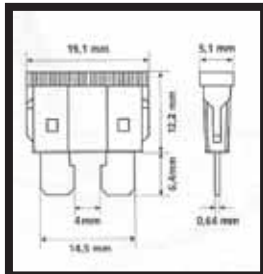

REF. 6470080

SET 10 FUSIBLES

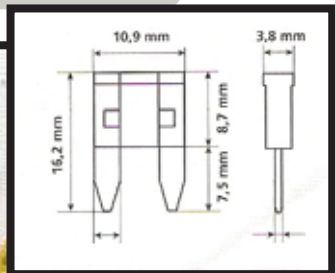
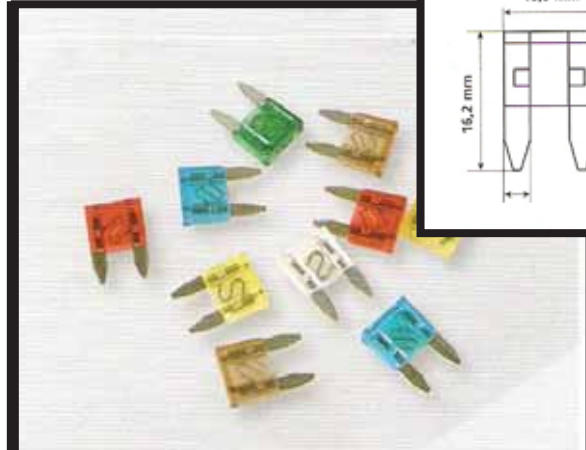

REF. 6470085

FUSIBLES MINIS BL.10 PZS.



REF. 6470121

JUEGO PINZAS BATERIA 15CM
120 AMP



REF. 6470124

JUEGO PINZAS BATERIA 7CM
40 AMP



REF. 6470126

JUEGO PINZAS BATERIA 10CM
60 AMP



REF. 6471990

LAMPARA FLEXO LARGO
12V 25CM



REF. 6472060

LAMPARA DE LECTURA NAVIGATOR



REF. 6474215

LAMPARA AVISADOR MATRAS
12V



REF. 6474511

TRANSFORMADOR
150W 12-220V



REF. 6474512

TRANSFORMADOR
300W 12-220V



REF. 6474513 500W 12-220V

REF. 6474514 700W 12-220V

REF. 6474515 1000W 12-220V

TRANSFORMADOR



REF. 6474520

TRANSFORMADOR 200W 12V



REF. 6439041

USB-1, TRASFORMATORE
12/24V>USB

REF. 6439042

USB-2, TRASFORMATORE
12/24V>USB



REF. 6470145

TRASFORMATORE
220-240V>12V



REF. 6470128

TRASFORMATORE
220V>12V



REF. 6470147

MULTITECH, KIT MOBILE DI RICARICA
12/24V



REF. 6445555

INTERRUPTOR A PRESIÓN
FORO 22,2 MM
PROF. MAX. 6 MM



REF. 6470123

CAVI BATTERIA EXPORT
12/24V
250 CM 500A



REF. 6472981

KALOR, SCALDINO, SBRINATORE
ELETTRICO
12V 160W



REF. 6439013

USB SCREW, PRESA USB CON SELECC-
TORE DI AMPERAGGIO
12/24V



REF. 6439005

EXT-8, DOPPIA PRESA USB
MONTAGGIO AD INCASSO
12/24V



REF. 6439048

DUAL-POWER, PRESA CORRENTE
TRIPLA CON USB
12/24V



REF. 6439039

POWER CENTERPRESA CORRENTE
DOPPIA CON USB
12/24V



REF. 6420539 BLANCO

REF. 6420540 ROJO

REF. 6420541 AMBAR

REFLECT. RECTANG BLANC 90X35 MM



REF. 6420544 BLANCO

REF. 6420545 AMBAR

REF. 6420546 ROJO

REFLECT. OVALADO BLANC 65 MM 2P

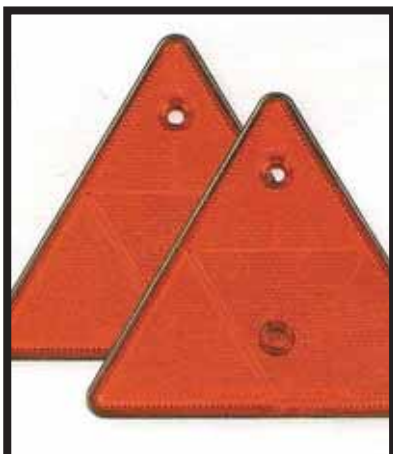

REF. 6420542

REFLECTANTE TRIAN-
GULAR ROJO
160 MM 2P



REF. 6441508 izda

REF. 6441507 Drcha

LUZ TRASERA ROJA. 12V
B. INCLUID



REF. 6441506

LUZ TRASERA. 4 FUN-
CIONES BASIC.
BOMBILLA INCLUIDA



REF. 6441516

CONJUNTO LUCES REMOLQUE
BOMBILLA INCLUIDA

MAGNÉTICO



REF. 6441517

CONJUNTO LUCES DE SEÑALI-
ZACIÓN POSTERIOR, MAGNETICO
12V



REF. 6438987
 ENCHUFE 7 POLOS
 160 CM DE CABLE



REF. 6438990
 ENCHUFE ADAPTADOR
 CPOLOS 13 MACHO



REF. 6438993
 ENCHUFE ADAPTADOR
 CPOLOS 7 MACHO



REF. 6438980
 ENCHUFE BLOQUEO AUTOMÁTICO
 7 POLOS



REF. 6438985
 ENCHUFE PLAST.
 CAMIONES - CARAVANAS



REF. 6438986
 ENCHUFE PLAST.
 CAMIONES - CARAVANAS



REF. 6402088 CEREZA

REF. 6402088 B VAINILLA

REF. 6402088 I SANDIA

REF. 6402088 J PINO

REF. 6402088 M MORA

AMBIENTADOR TASOTTI
MAD. COLG. 7ML

